

1: 10,6*	↖
2: 9,6	↗
3: 10,3*	→
4: 9,7	↗
5: 10,7*	→
6: 10,4*	↘
7: 10,2	↖
Serie: 68,0	
Summa: 0,0	

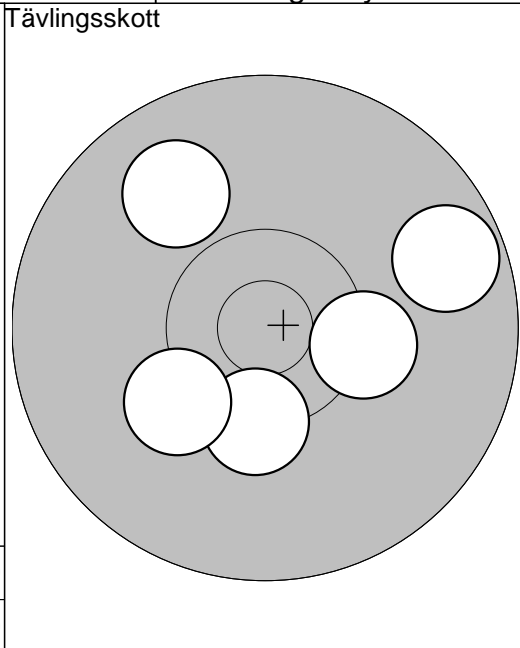

1: 10,3*	↘
2: 9,9	↖
3: 10,3*	→
4: 9,7	↗
5: 10,2	↙
Serie: 48,0	
Summa: 48,0	

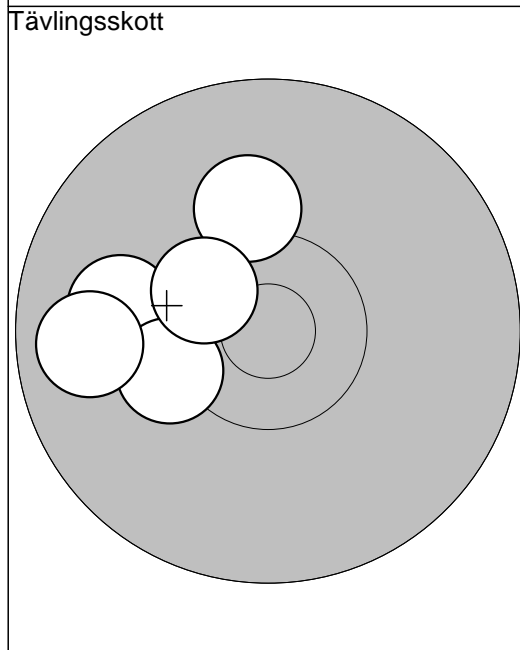

6: 10,1	↑
7: 10,0	←
8: 10,3	←
9: 10,5*	↖
10: 9,8	←
Serie: 49,0	
Summa: 97,0	

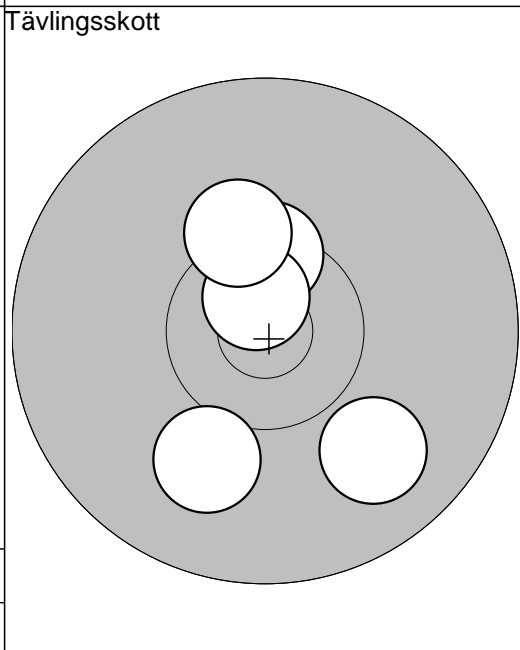

11: 10,0	↙
12: 10,5*	↑
13: 10,7*	↑
14: 9,9	↘
15: 10,3*	↑
Serie: 49,0	
Summa: 146,0	

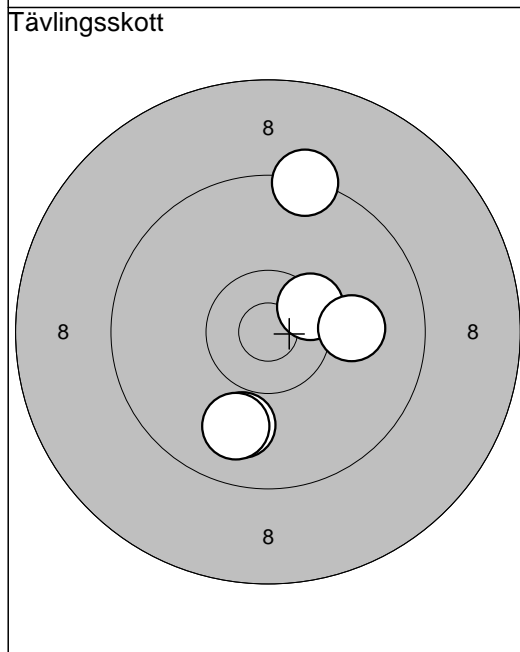

16: 9,3	↑
17: 9,9	↘
18: 9,9	↘
19: 10,4*	↗
20: 10,1	→
Serie: 47,0	
Summa: 193,0	

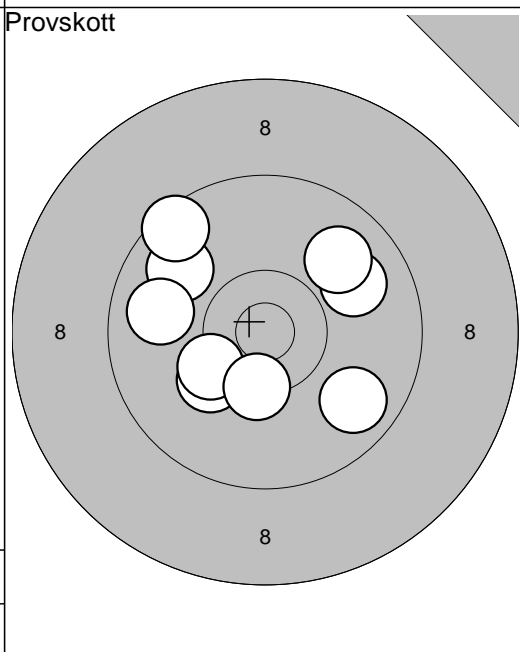

1: 10,2	↙
2: 9,8	↖
3: 10,3	↙
4: 10,4*	↘
5: 9,9	↗
6: 9,8	←
7: 9,8	↘
8: 9,5	↖
9: 9,9	↗
Serie: 84,0	
Summa: 193,0	

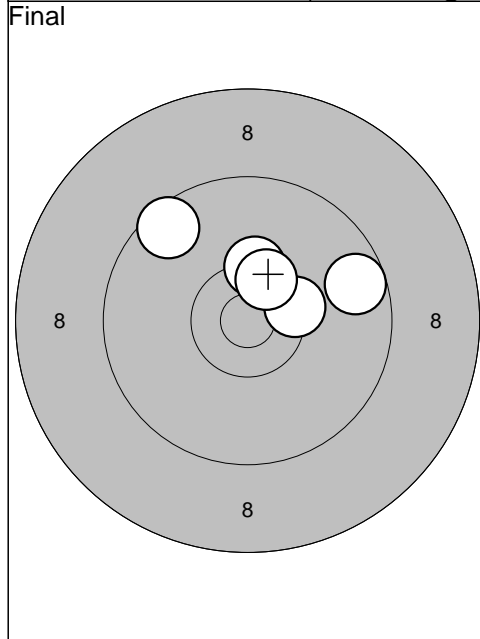

1: 9,6	↖
2: 10,3*	↑
3: 10,4*	→
4: 9,6	→
5: 10,4*	↑
Serie: 48,0	
Summa: 241,0	

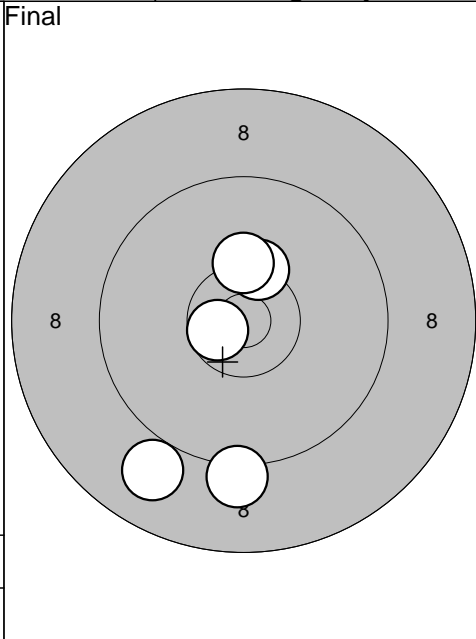

6: 9,0	↙
7: 10,4*	↑
8: 10,6*	←
9: 10,3*	↑
10: 9,2	↓
Serie: 48,0	
Summa: 289,0	

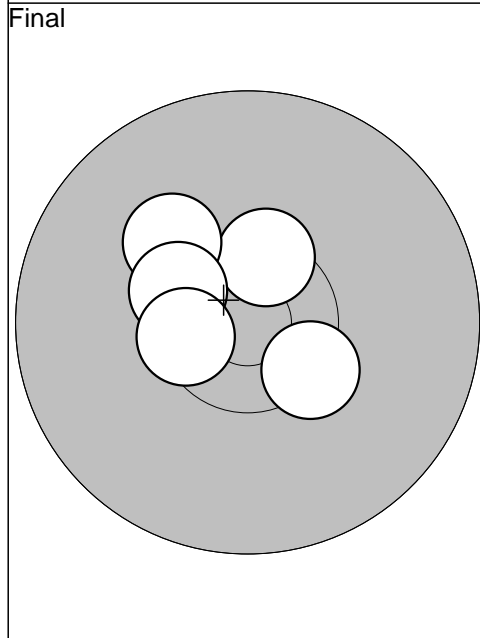

11: 10,5*	↑
12: 10,2	↖
13: 10,4*	↘
14: 10,4*	↖
15: 10,5*	←
Serie: 50,0	
Summa: 339,0	

--	--

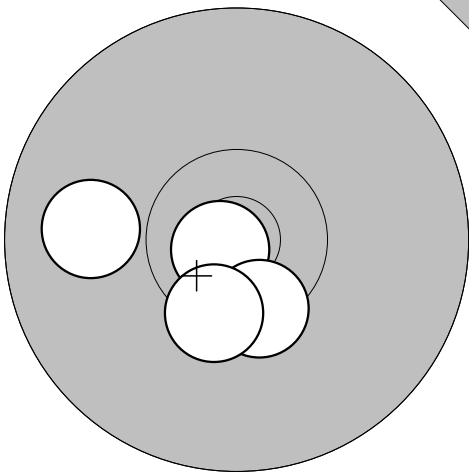
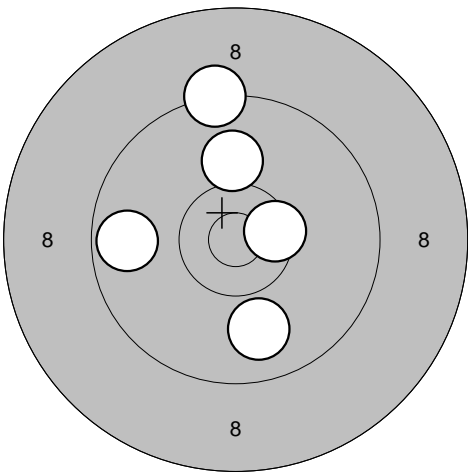
<p>Provsnitt</p> 	<p>1: 10,8* ↙ 2: 10,4* ↓ 3: 10,4* ↓ 4: 9,9 ←</p>	<p>Tävlingssnitt</p> 	<p>1: 10,1 ↑ 2: 10,5* → 3: 9,9 ↓ 4: 9,7 ← 5: 9,3 ↑</p>
Serie: 39,0		Serie: 47,0	
Summa: 0,0		Summa: 47,0	

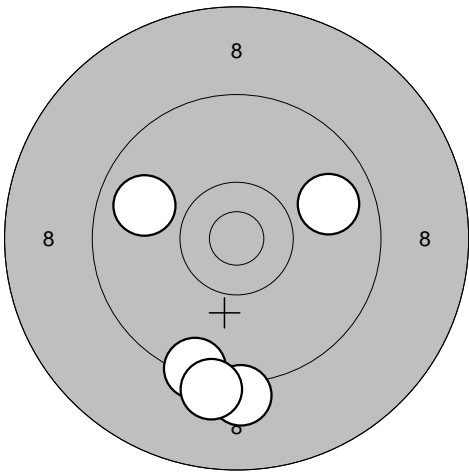
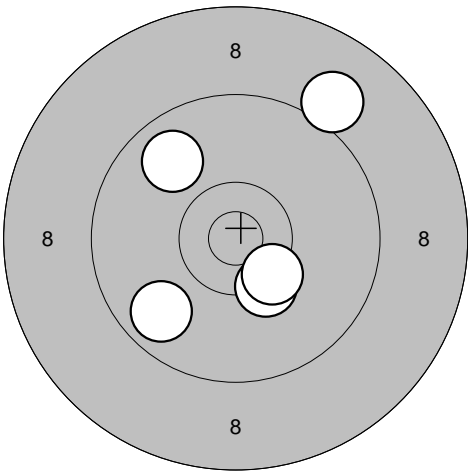
<p>Tävlingssnitt</p> 	<p>6: 9,2 ↓ 7: 9,4 ↓ 8: 9,8 → 9: 9,8 ← 10: 9,2 ↓</p>	<p>Tävlingssnitt</p> 	<p>11: 9,0 ↗ 12: 9,8 ↗ 13: 10,3* ↓ 14: 9,8 ← 15: 10,4* ↓</p>
Serie: 45,0		Serie: 47,0	
Summa: 92,0		Summa: 139,0	

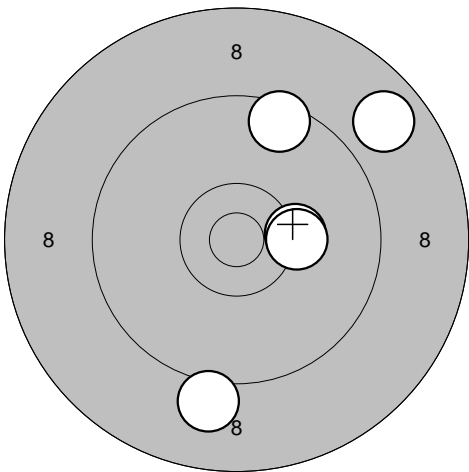
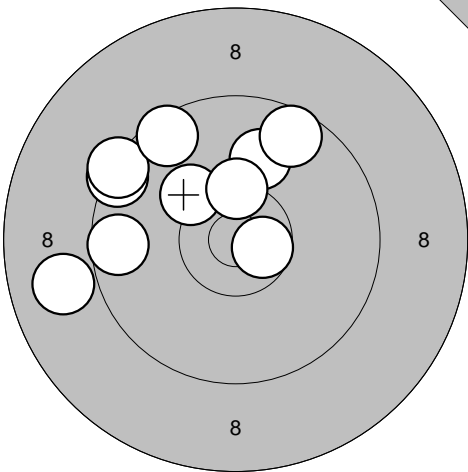
<p>Tävlingssnitt</p> 	<p>16: 9,1 ↓ 17: 10,3 → 18: 8,8 ↗ 19: 10,3 → 20: 9,5 ↑</p>	<p>Provsnitt</p> 	<p>1: 9,4 ↙ 2: 9,4 ↙ 3: 9,6 ← 4: 10,2 ↗ 5: 8,9 ← 6: 10,0 ↑ 7: 10,4* ↑ 8: 10,6* → 9: 9,5 ↗ 10: 9,6 ↗</p>
Serie: 46,0		Serie: 93,0	
Summa: 185,0		Summa: 185,0	

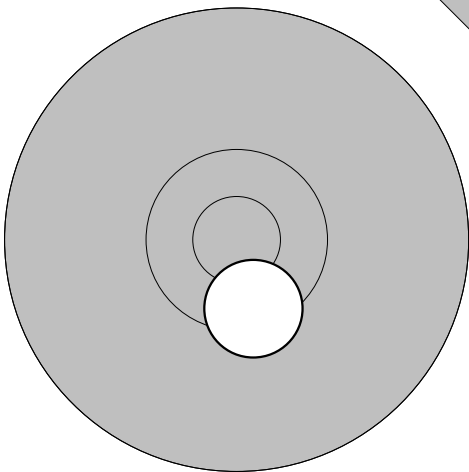
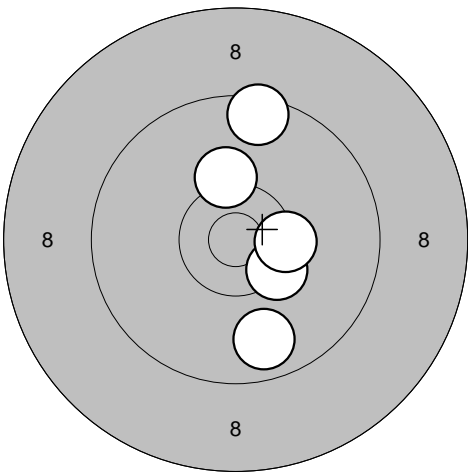
Provs-kott 	11: 10,4* ↓ Final 	1: 10,4* ↘ 2: 9,8 ↓ 3: 10,4* → 4: 9,5 ↑ 5: 10,2 ↑
Serie: 10,0	Serie: 48,0	
Summa: 185,0	Summa: 233,0	

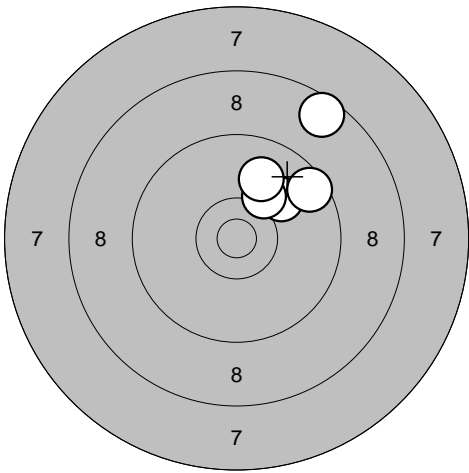
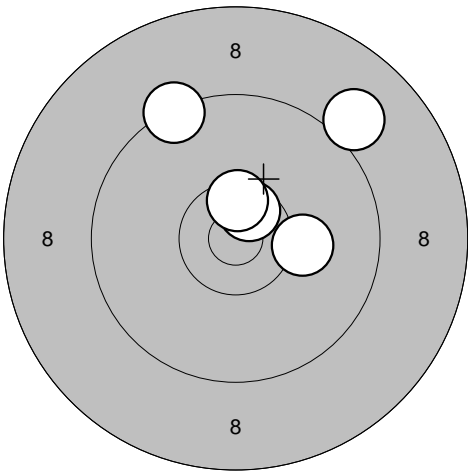
Final 	6: 8,6 ↗ 7: 10,0 ↗ 8: 10,2 ↗ 9: 9,6 ↗ 10: 9,9 ↑	Final 	11: 10,6* ↗ 12: 10,5* ↑ 13: 9,4 ↖ 14: 9,0 ↗ 15: 10,2 →
Serie: 46,0	Serie: 48,0		
Summa: 279,0	Summa: 327,0		

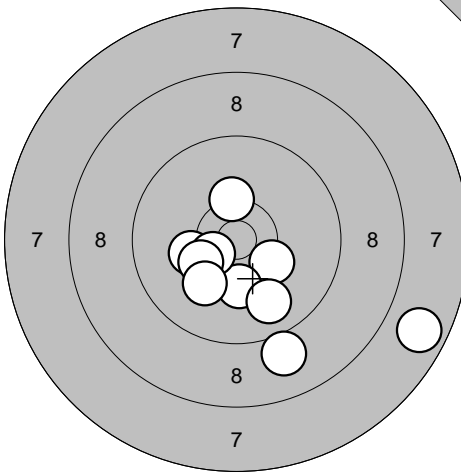
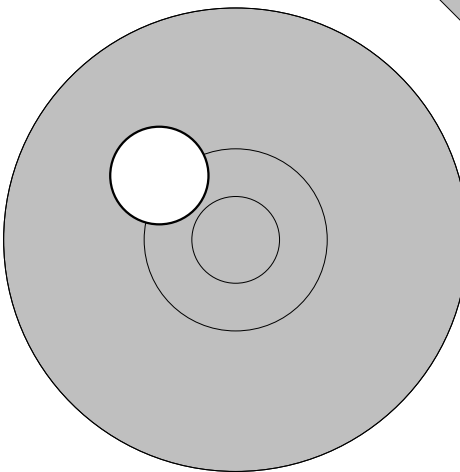
<p>Provskott</p> 	<p>1: 7,7 ↘ 2: 9,0 ↓ 3: 10,3 ↘ 4: 10,2 ↓ 5: 10,3* ↑ 6: 10,2 ← 7: 10,5* ↙ 8: 10,3* ↙ 9: 10,1 ↙ 10: 9,9 ↓</p> <p>Serie: 95,0 Summa: 0,0</p>	<p>Provskott</p>  <p>11: 10,2 ↖</p> <p>Serie: 10,0 Summa: 0,0</p>
---	---	---

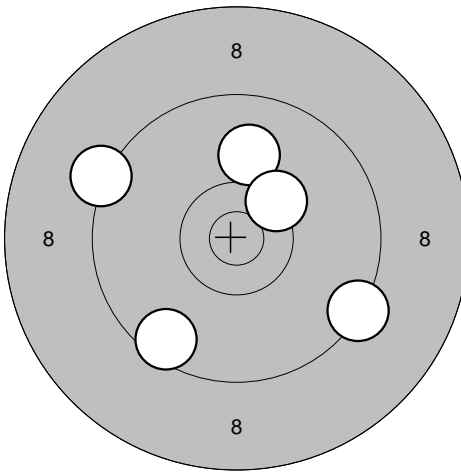
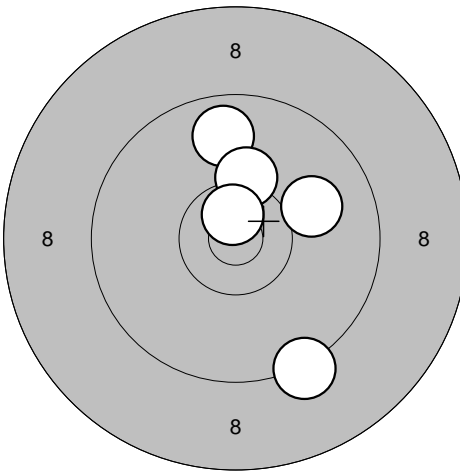
<p>Tävlingsskott</p> 	<p>1: 9,5 ↙ 2: 10,0 ↑ 3: 9,3 ↘ 4: 10,3* ↗ 5: 9,3 ↖</p> <p>Serie: 47,0 Summa: 47,0</p>	<p>Tävlingsskott</p>  <p>6: 9,3 ↓ 7: 9,8 ↑ 8: 10,0 → 9: 10,2 ↑ 10: 10,7* ↑</p> <p>Serie: 48,0 Summa: 95,0</p>
--	---	--

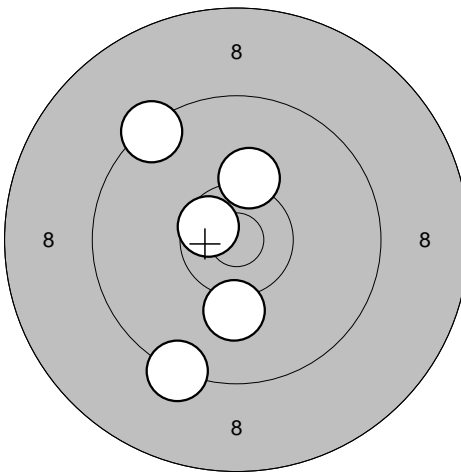
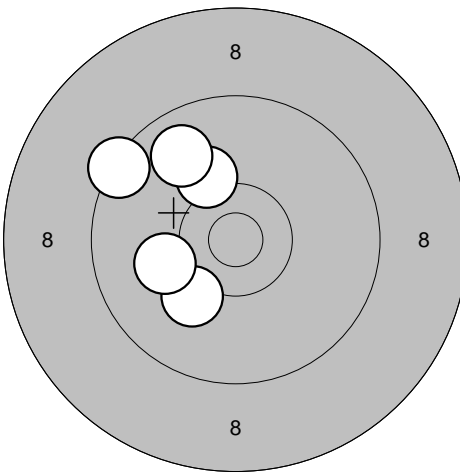
<p>Tävlingsskott</p> 	<p>11: 10,6* ↖ 12: 9,3 ↓ 13: 9,4 ↗ 14: 10,2 ↑ 15: 10,1 ↓</p> <p>Serie: 48,0 Summa: 143,0</p>	<p>Tävlingsskott</p>  <p>16: 10,1 ↙ 17: 10,1 ← 18: 10,2 ↗ 19: 9,8 ↗ 20: 9,4 ↖</p> <p>Serie: 48,0 Summa: 191,0</p>
---	--	---

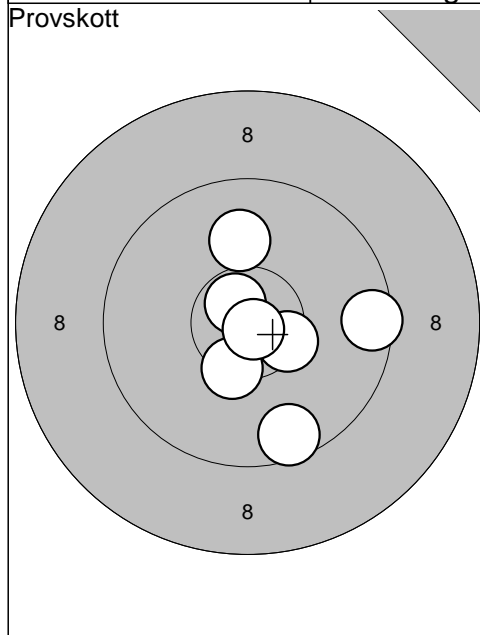

1: 9,6	↘
2: 9,5	→
3: 10,7*	↗
4: 10,4*	↘
5: 10,4*	↘
6: 10,8*	↘
7: 10,0	↗
<hr/>	
Serie:	68,0
Summa:	191,0

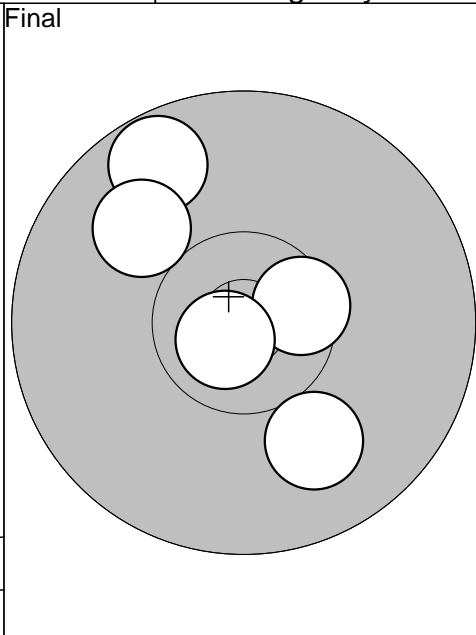

1: 9,7	↗
2: 10,5*	→
3: 10,0	↗
4: 10,0	↘
5: 10,8*	↘
<hr/>	
Serie:	49,0
Summa:	240,0

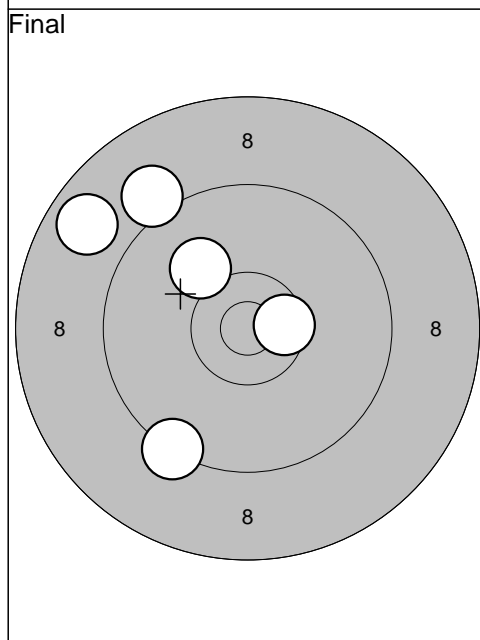

6: 10,1	↗
7: 9,1	↗
8: 9,3	↘
9: 10,5*	→
10: 8,8	↗
<hr/>	
Serie:	46,0
Summa:	286,0

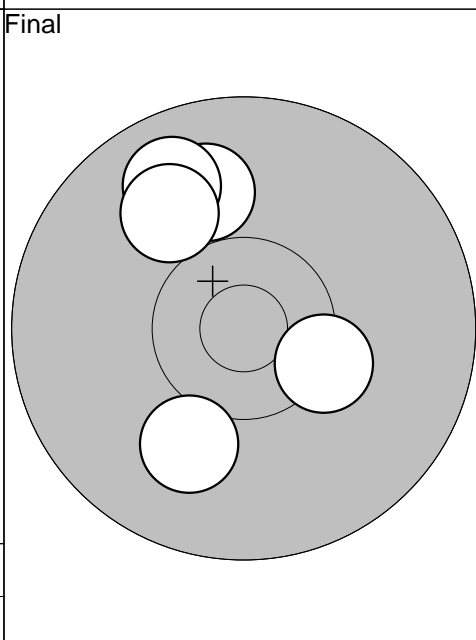

11: 10,0	↗
12: 10,3*	→
13: 9,8	↗
14: 10,0	↗
15: 10,0	↘
<hr/>	
Serie:	49,0
Summa:	335,0

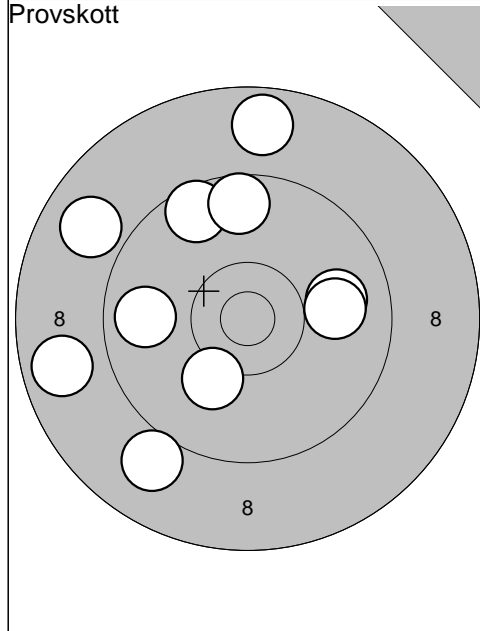

1: 8,7	↑
2: 9,8	←
3: 8,9	↖
4: 10,2	↓
5: 9,9	→
6: 8,8	←
7: 9,0	↓
8: 9,6	↑
9: 9,6	↑
10: 9,9	→
Serie:	88,0
Summa:	0,0

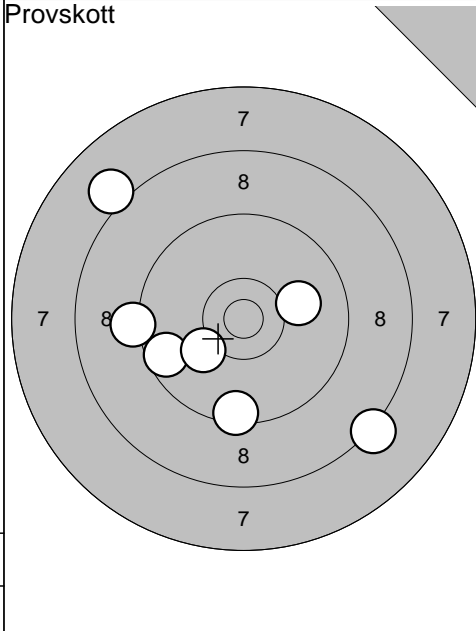

11: 10,0	→
12: 9,6	←
13: 9,5	↓
14: 9,2	←
15: 8,1	↖
16: 8,2	↘
17: 10,1	↙
Serie:	63,0
Summa:	0,0

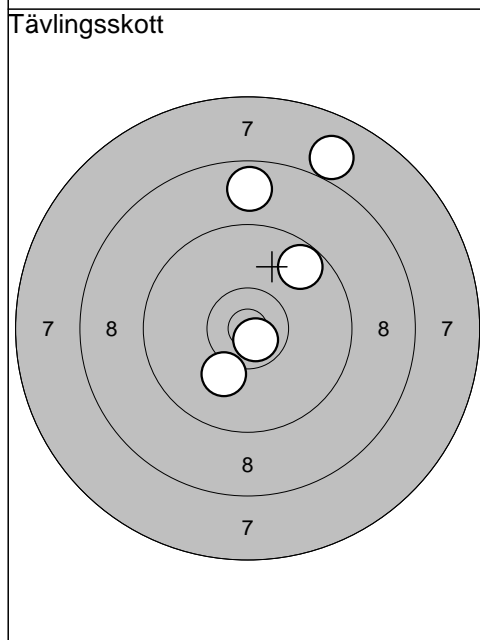

1: 8,0	↗
2: 8,8	↑
3: 10,1	↘
4: 10,7*	↘
5: 9,7	↗
Serie:	45,0
Summa:	45,0

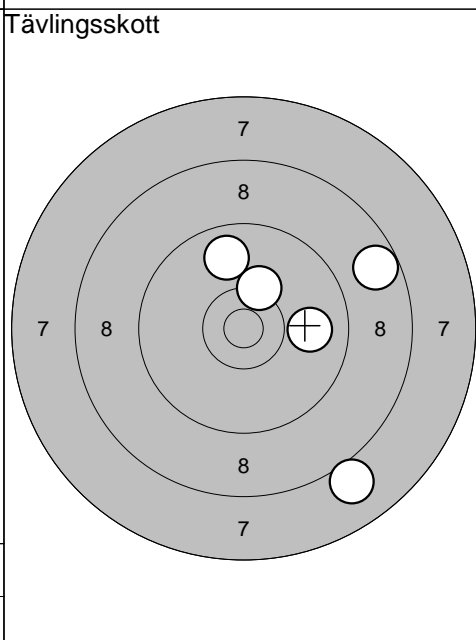

6: 9,9	→
7: 10,3	↗
8: 9,8	↑
9: 8,7	↗
10: 8,0	↘
Serie:	44,0
Summa:	89,0

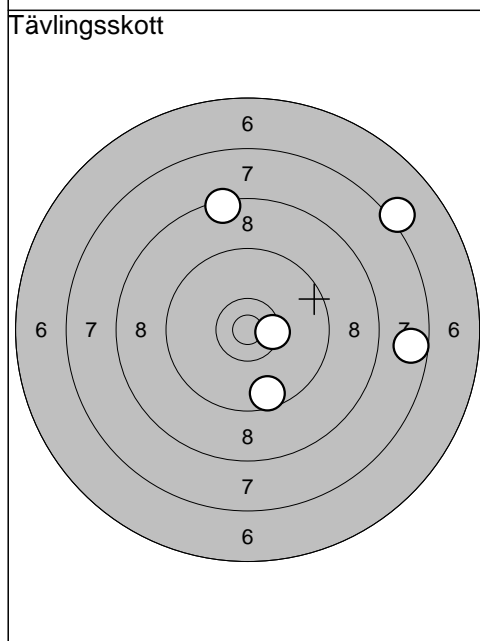

11: 10,4*	→
12: 8,4	↑
13: 7,2	↗
14: 9,6	↓
15: 7,7	→
Serie:	41,0
Summa:	130,0

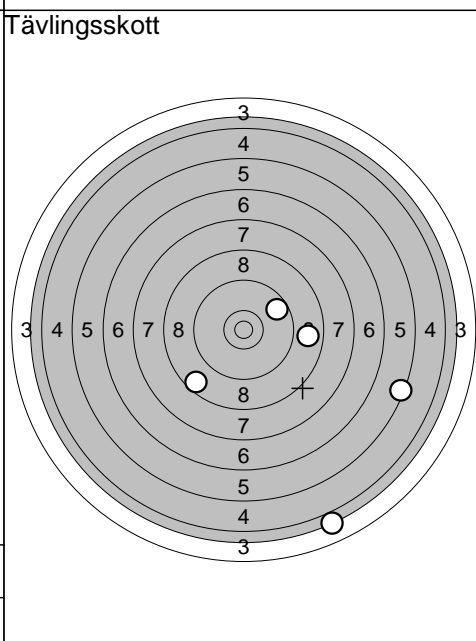

16: 8,8	→
17: 8,6	↙
18: 3,9	↓
19: 9,7	↗
20: 5,4	→
Serie:	33,0
Summa:	163,0

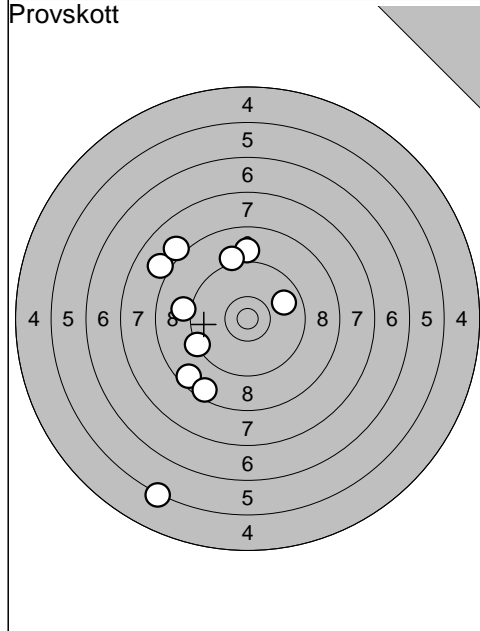

1: 5,3	↙
2: 8,6	↙
3: 8,6	↙
4: 8,0	↖
5: 9,8	➔
6: 9,0	↑
7: 9,1	↖
8: 8,1	↗
9: 9,3	↙
10: 9,2	↑
Serie:	82,0
Summa:	0,0

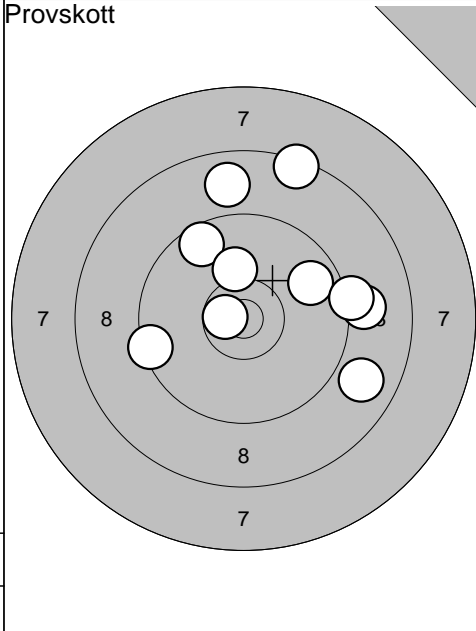

11: 9,6	↖
12: 9,0	➔
13: 10,2	↑
14: 10,7*	↖
15: 8,4	↗
16: 9,7	↗
17: 9,2	➔
18: 8,8	↑
19: 9,4	↖
20: 8,9	↘
Serie:	89,0
Summa:	0,0

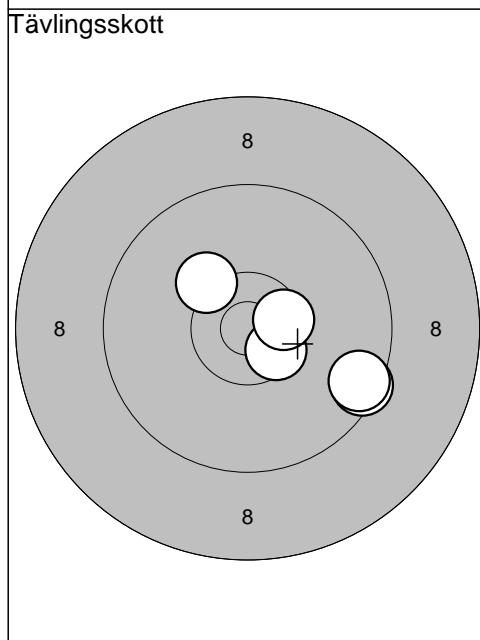

1: 10,5*	↘
2: 9,5	➔
3: 10,3	↗
4: 9,5	➔
5: 10,5*	➔
Serie:	48,0
Summa:	48,0

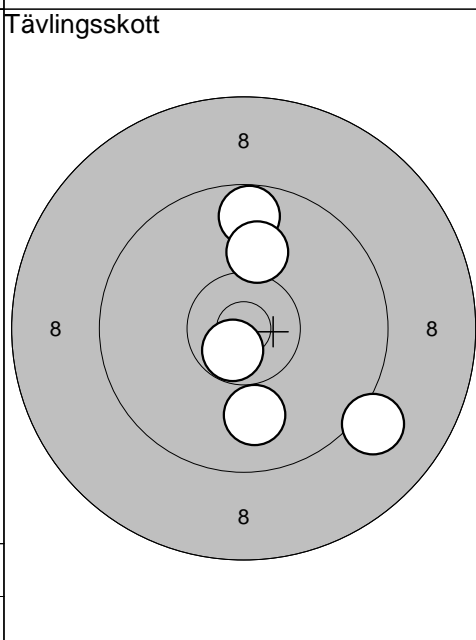

6: 10,7*	↘
7: 9,7	↑
8: 10,0	↓
9: 9,1	↘
10: 10,1	↑
Serie:	48,0
Summa:	96,0

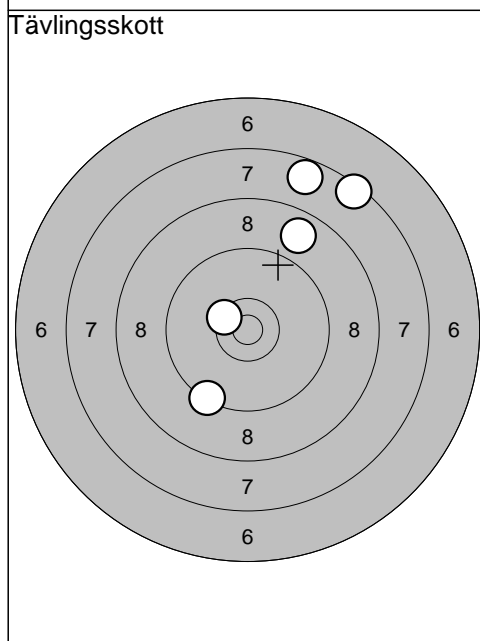

11: 8,8	↗
12: 7,7	↑
13: 9,4	↙
14: 7,5	↗
15: 10,4*	↖
Serie:	41,0
Summa:	137,0

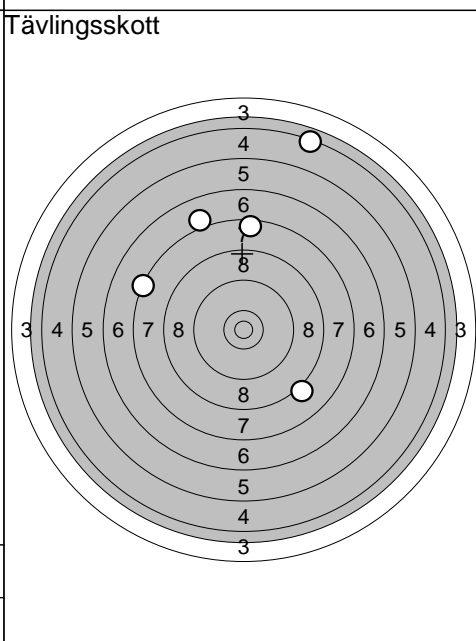

16: 7,4	↖
17: 7,1	↗
18: 4,4	↗
19: 7,6	↑
20: 8,2	↘
Serie:	33,0
Summa:	170,0

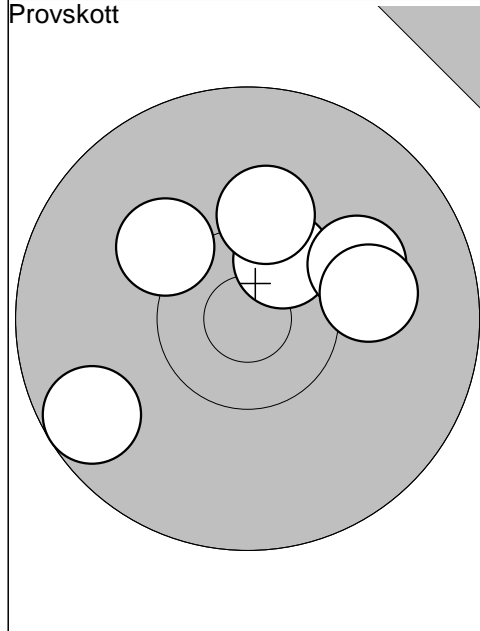

1: 10,5*	↗
2: 10,1	→
3: 9,7	↙
4: 10,2	↑
5: 10,1	→
6: 10,2	↖
Serie: 59,0	
Summa: 170,0	

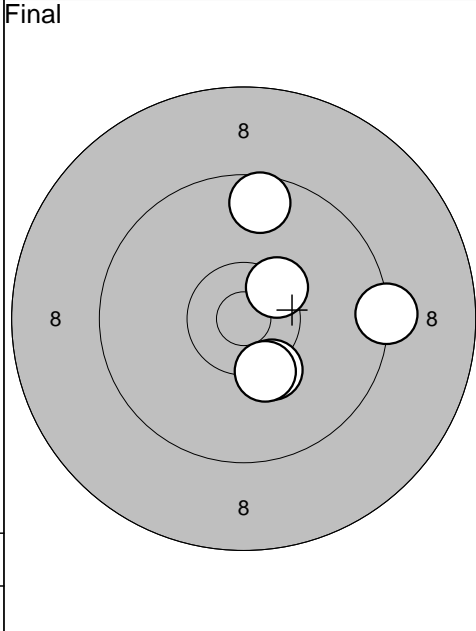

1: 10,4*	↗
2: 9,3	→
3: 10,3	↘
4: 9,6	↑
5: 10,3*	↘
Serie: 48,0	
Summa: 218,0	

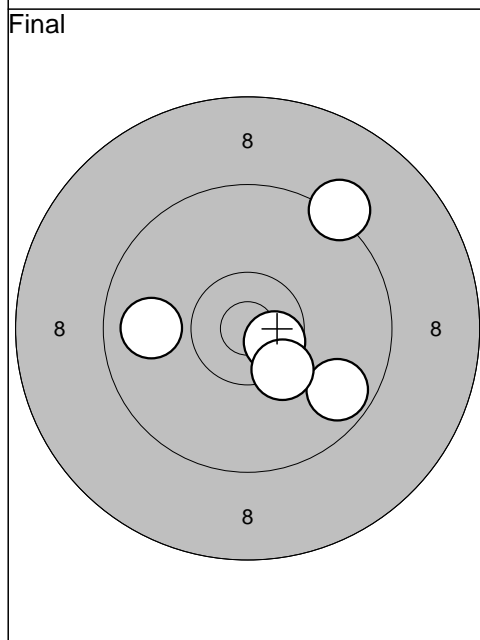

6: 9,7	↘
7: 9,2	↗
8: 9,9	←
9: 10,6*	↘
10: 10,3*	↘
Serie: 47,0	
Summa: 265,0	

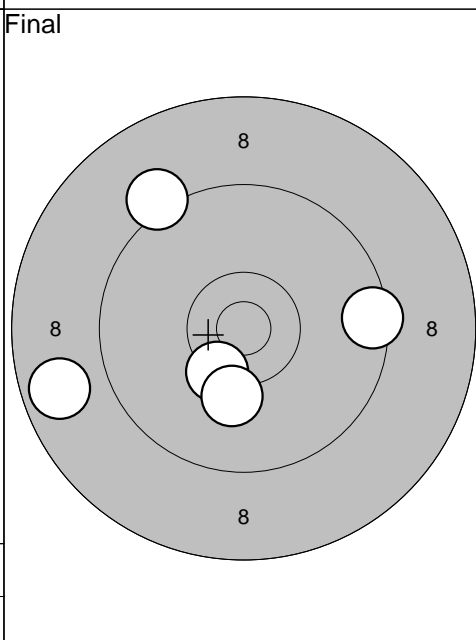

11: 9,2	↖
12: 8,7	←
13: 10,4*	↘
14: 10,2	↘
15: 9,5	→
Serie: 46,0	
Summa: 311,0	

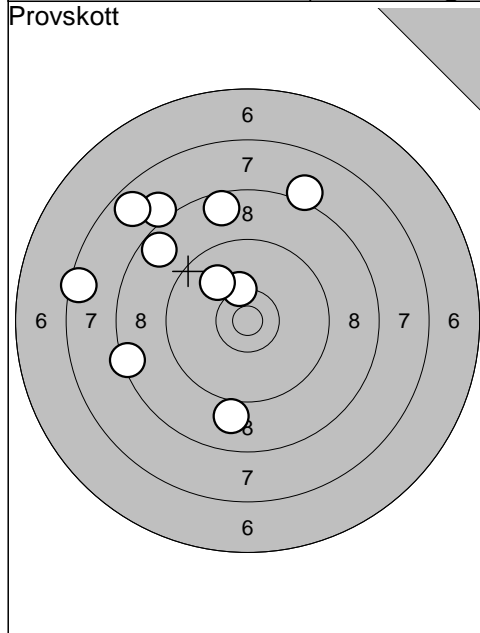

1: 8,1	↗
2: 7,7	↗
3: 8,1	↗
4: 7,5	←
5: 10,3*	↗
6: 8,7	↗
7: 8,6	↗
8: 10,0	↗
9: 8,4	←
10: 9,0	↓
Serie:	83,0
Summa:	0,0

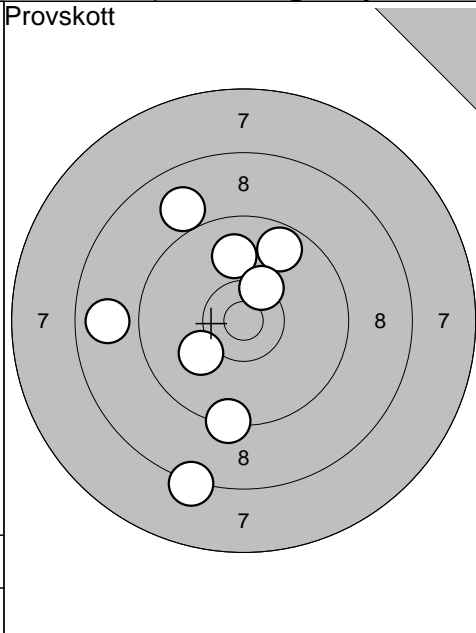

11: 8,8	←
12: 10,1	↙
13: 8,3	↓
14: 9,9	↑
15: 9,4	↓
16: 9,7	↗
17: 9,0	↖
18: 10,4*	↗
Serie:	72,0
Summa:	0,0

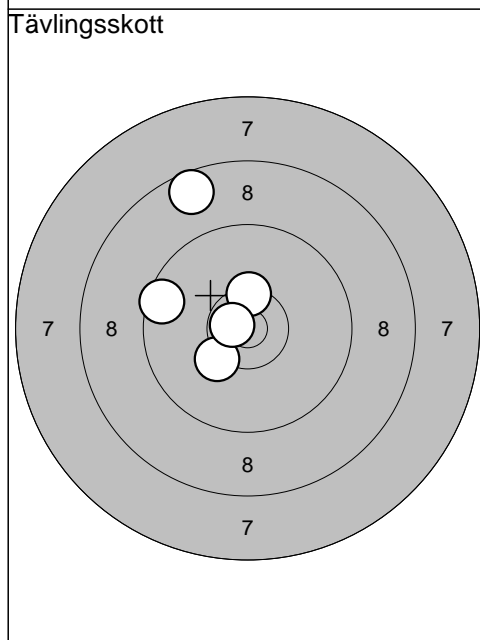

1: 10,4*	↑
2: 8,6	↗
3: 10,3	↙
4: 10,7*	←
5: 9,5	←
Serie:	47,0
Summa:	47,0

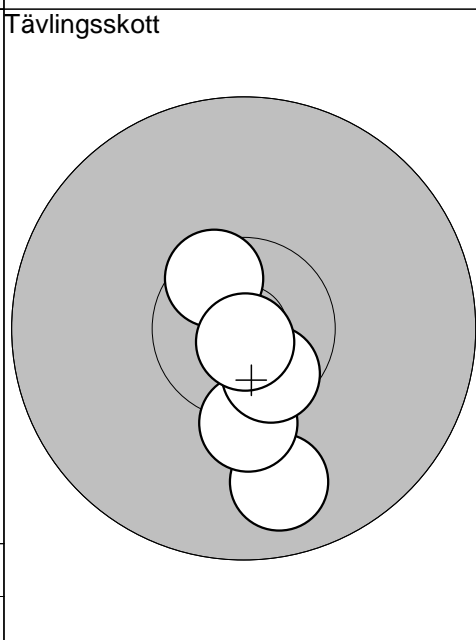

6: 10,5*	↗
7: 9,8	↓
8: 10,3	↓
9: 10,6*	↓
10: 10,8*	↓
Serie:	49,0
Summa:	96,0

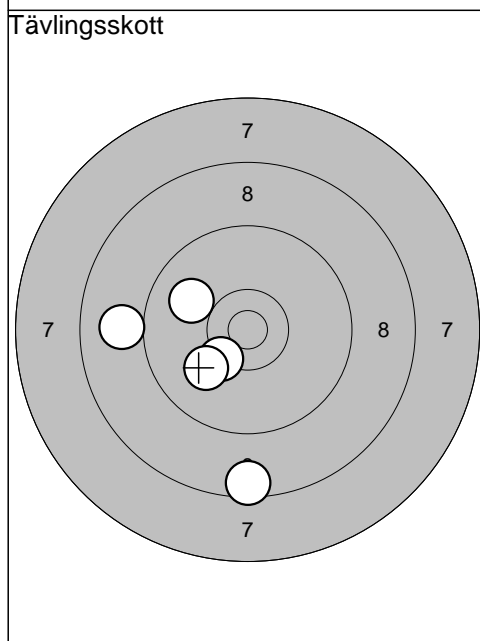

11: 10,0	↙
12: 10,3*	↙
13: 10,1	↙
14: 8,5	↓
15: 9,0	←
Serie:	47,0
Summa:	143,0

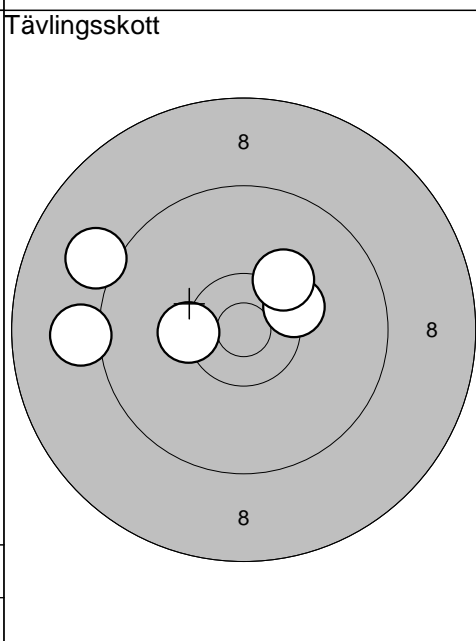

16: 9,1	↙
17: 10,3*	↗
18: 9,1	←
19: 10,3*	←
20: 10,2	↗
Serie:	48,0
Summa:	191,0

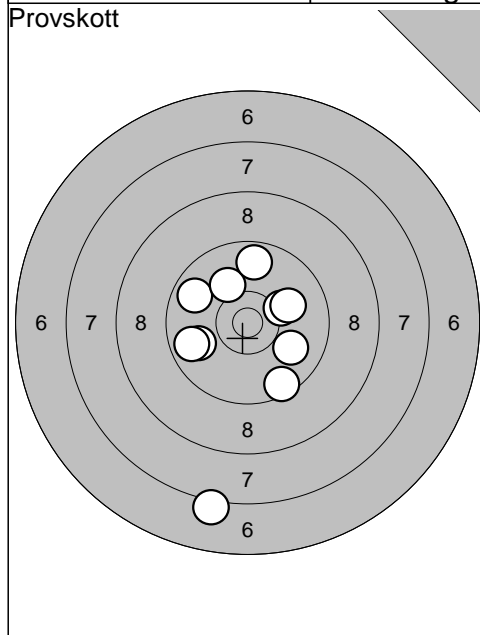

1: 9,8	↖
2: 10,2	➔
3: 7,2	⏚
4: 9,9	↙
5: 9,8	↙
6: 9,9	➔
7: 10,1	↗
8: 9,5	⏚
9: 10,1	➔
10: 9,7	↑
Serie: 91,0	
Summa: 191,0	

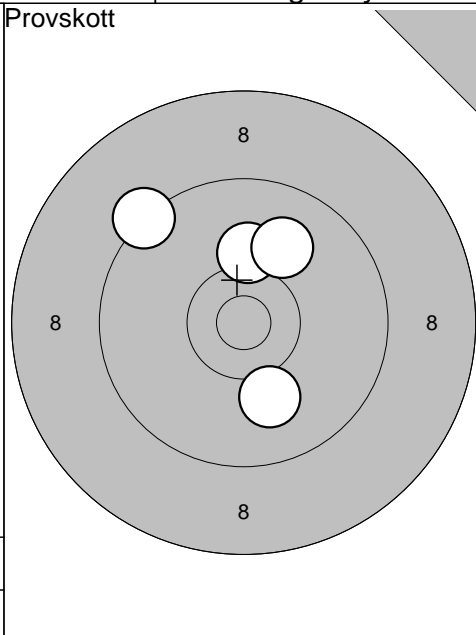

11: 10,2	↑
12: 10,0	⏚
13: 9,3	↖
14: 10,0	↗
Serie: 39,0	
Summa: 191,0	

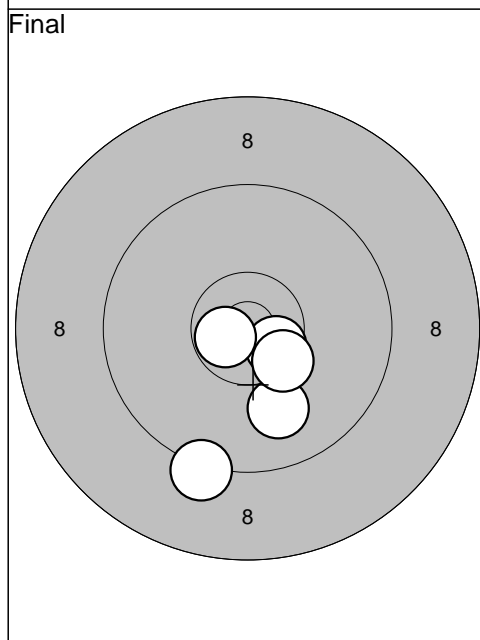

1: 10,0	⏚
2: 10,6*	➔
3: 10,7*	↙
4: 10,4*	➔
5: 9,2	⏚
Serie: 49,0	
Summa: 240,0	

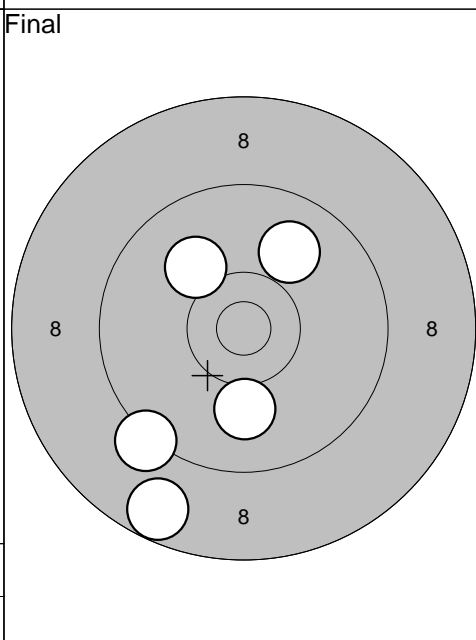

6: 10,0	⏚
7: 8,7	⏚
8: 10,1	↖
9: 9,2	↙
10: 9,9	↗
Serie: 46,0	
Summa: 286,0	

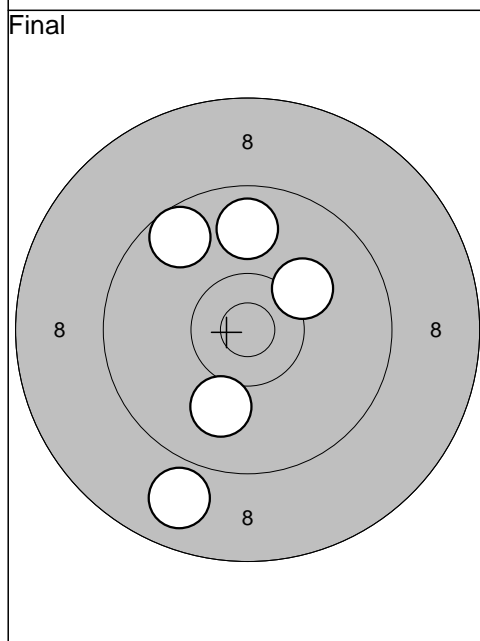

11: 8,9	⏚
12: 9,8	↑
13: 10,2	➔
14: 10,0	⏚
15: 9,6	↖
Serie: 46,0	
Summa: 332,0	

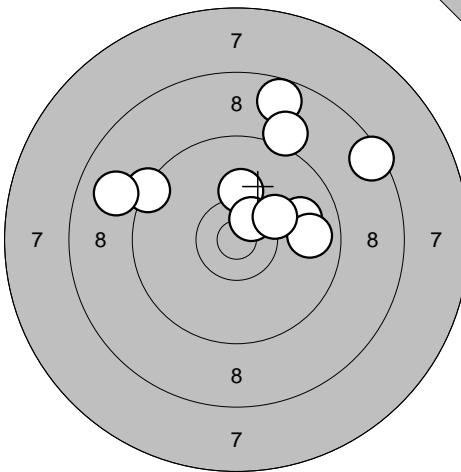
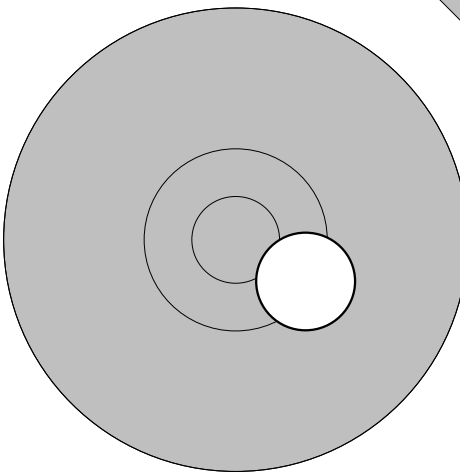
<p>Provskott</p> 	<p>1: 9,4 ↖ 2: 10,2 ↑ 3: 8,7 ↑ 4: 9,9 → 5: 9,8 → 6: 8,5 → 7: 9,1 ↑ 8: 10,6* ↑ 9: 10,3 → 10: 8,9 ↖</p>	<p>Provskott</p> 	<p>11: 10,4* ↘</p>
Serie: 90,0		Serie: 10,0	
Summa: 0,0		Summa: 0,0	

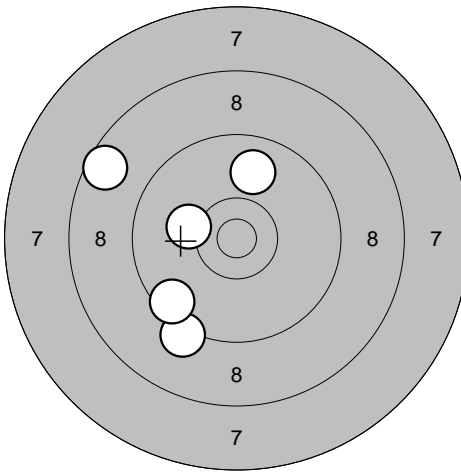
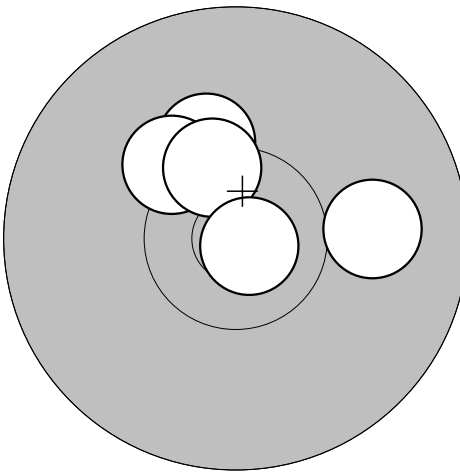
<p>Tävlingsskott</p> 	<p>1: 9,9 ↑ 2: 9,2 ↘ 3: 9,5 ↘ 4: 10,2 ↖ 5: 8,6 ↖</p>	<p>Tävlingsskott</p> 	<p>6: 10,2 ↑ 7: 10,3 ↖ 8: 10,4* ↑ 9: 10,8* ↘ 10: 10,0 →</p>
Serie: 45,0		Serie: 50,0	
Summa: 45,0		Summa: 95,0	

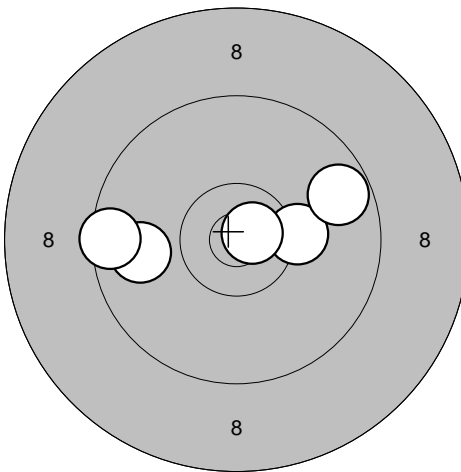
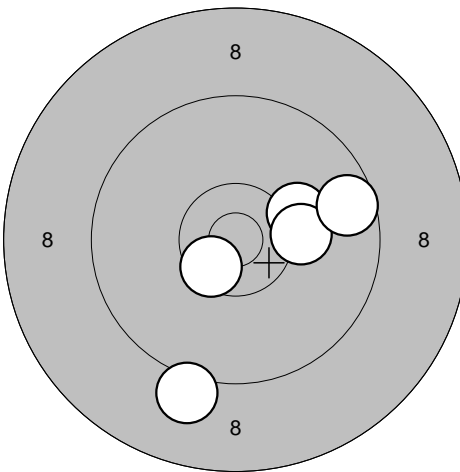
<p>Tävlingsskott</p> 	<p>11: 9,8 ↖ 12: 10,3 → 13: 9,5 ↖ 14: 10,8* → 15: 9,7 →</p>	<p>Tävlingsskott</p> 	<p>16: 10,2 → 17: 10,2 → 18: 9,1 ↘ 19: 9,6 → 20: 10,5* ↘</p>
Serie: 47,0		Serie: 48,0	
Summa: 142,0		Summa: 190,0	

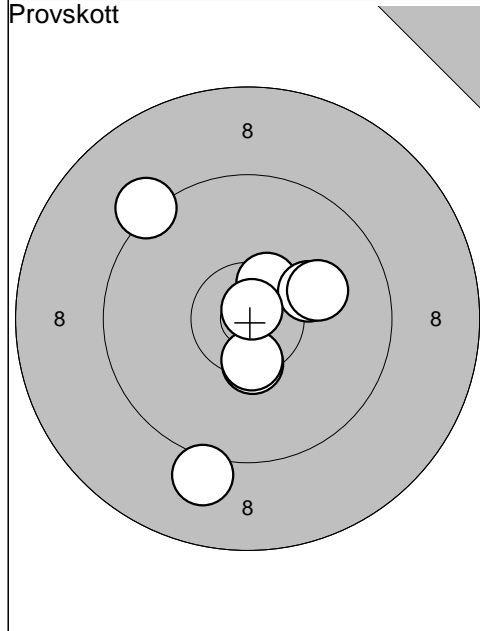

1: 10,4*	↓
2: 9,1	↓
3: 9,2	↖
4: 10,5*	↗
5: 10,2	→
6: 10,1	→
7: 10,5*	↓
8: 10,8*	↗
Serie: 78,0	
Summa: 190,0	

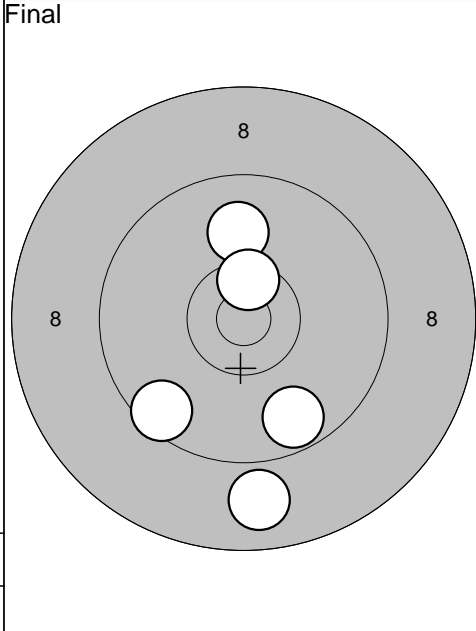

1: 10,0	↑
2: 9,7	↘
3: 10,5*	↑
4: 8,9	↓
5: 9,5	↙
Serie: 46,0	
Summa: 236,0	

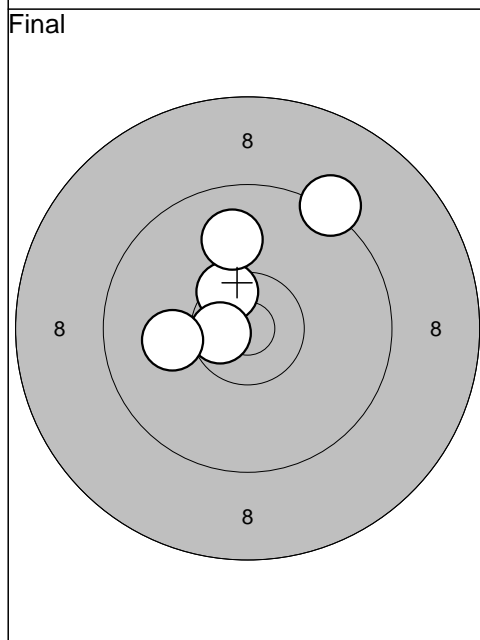

6: 10,5*	↖
7: 9,9	↑
8: 9,3	↗
9: 10,6*	←
10: 10,1	←
Serie: 48,0	
Summa: 284,0	

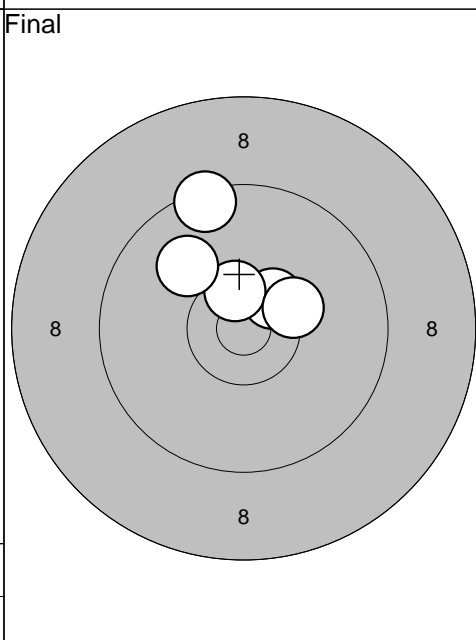

11: 10,5*	↗
12: 10,5*	↑
13: 10,3*	→
14: 9,4	↑
15: 10,0	↖
Serie: 49,0	
Summa: 333,0	

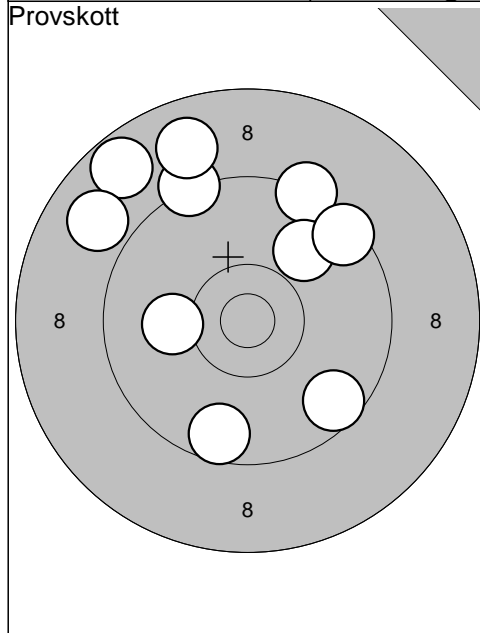

1: 8,7	↗
2: 9,6	↘
3: 9,3	↗
4: 9,3	↗
5: 9,9	↗
6: 8,9	↗
7: 9,5	↗
8: 10,1	←
9: 9,6	↘
10: 8,9	↖
Serie: 88,0	
Summa: 0,0	

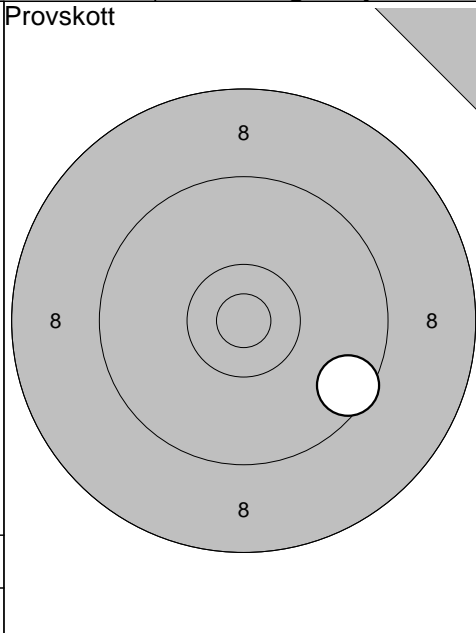

11: 9,5	↘
Serie: 9,0	
Summa: 0,0	

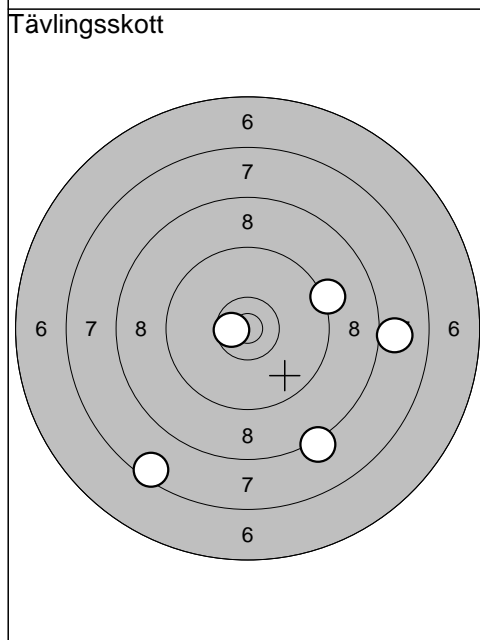

1: 8,0	→
2: 9,2	→
3: 7,5	↘
4: 10,6*	←
5: 8,2	↘
Serie: 42,0	
Summa: 42,0	

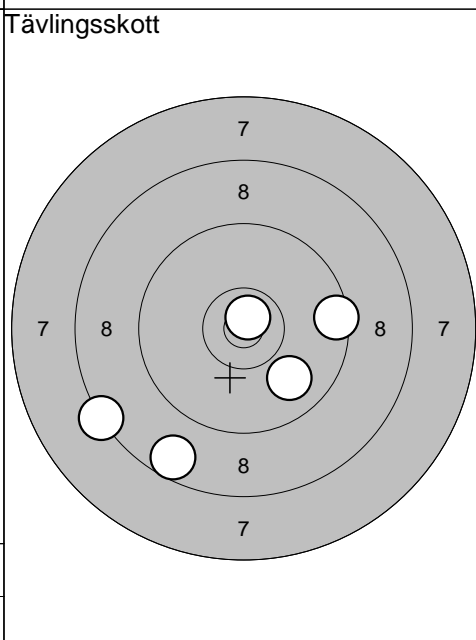

6: 9,5	→
7: 8,6	↘
8: 10,8*	↗
9: 9,9	↘
10: 8,3	↖
Serie: 44,0	
Summa: 86,0	

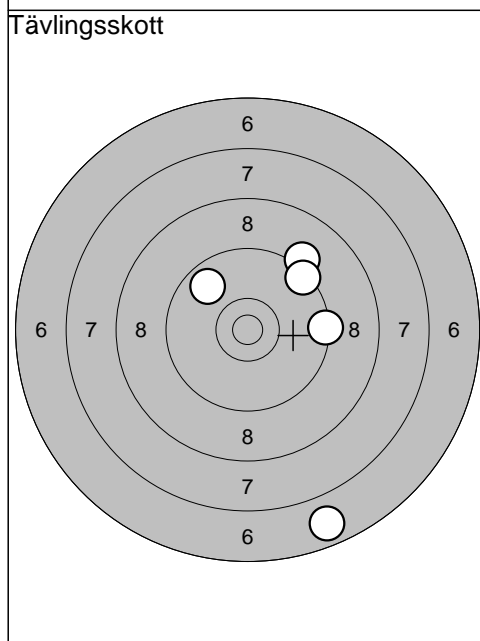

11: 6,7	↘
12: 9,2	↗
13: 9,4	→
14: 9,4	↗
15: 9,8	↖
Serie: 42,0	
Summa: 128,0	

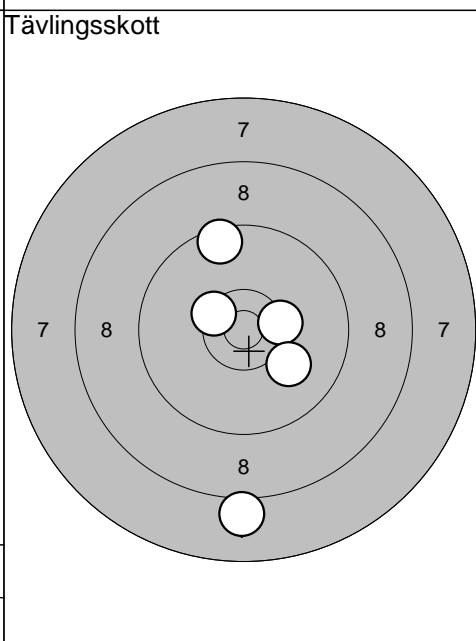

16: 10,4*	→
17: 10,1	↘
18: 8,0	↘
19: 10,4*	↖
20: 9,5	↗
Serie: 47,0	
Summa: 175,0	

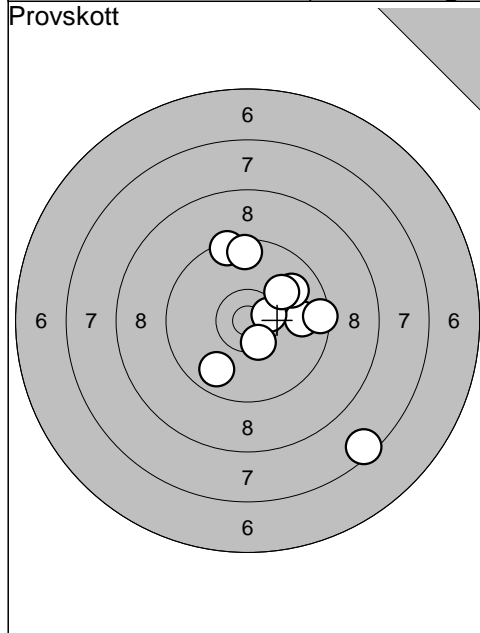

1: 9,9	→
2: 9,4	↑
3: 9,8	↙
4: 9,6	↑
5: 10,5*	→
6: 7,5	↘
7: 9,9	↗
8: 10,1	↗
9: 9,5	→
10: 10,5*	↘
Serie: 91,0	
Summa: 175,0	

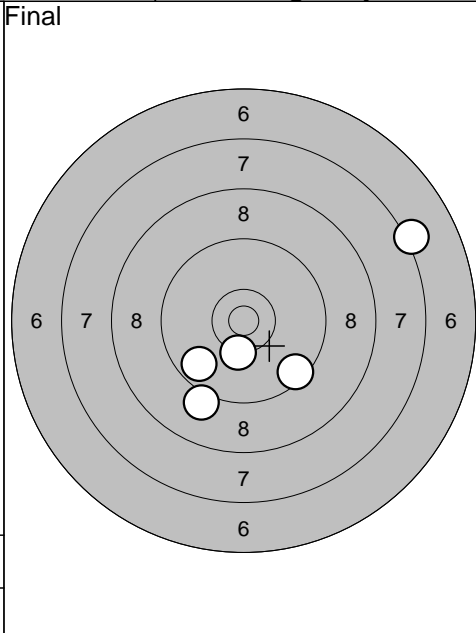

1: 9,5	↘
2: 7,2	↗
3: 9,7	↙
4: 10,3*	↘
5: 9,1	↙
Serie: 44,0	
Summa: 219,0	

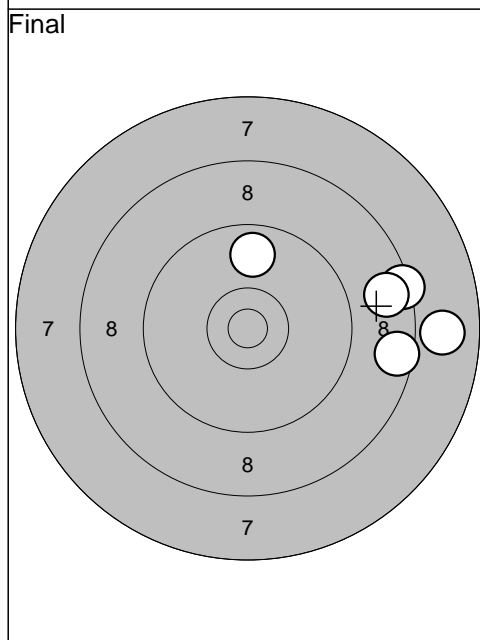

6: 9,8	↑
7: 8,6	→
8: 8,4	→
9: 8,7	→
10: 7,9	→
Serie: 40,0	
Summa: 259,0	

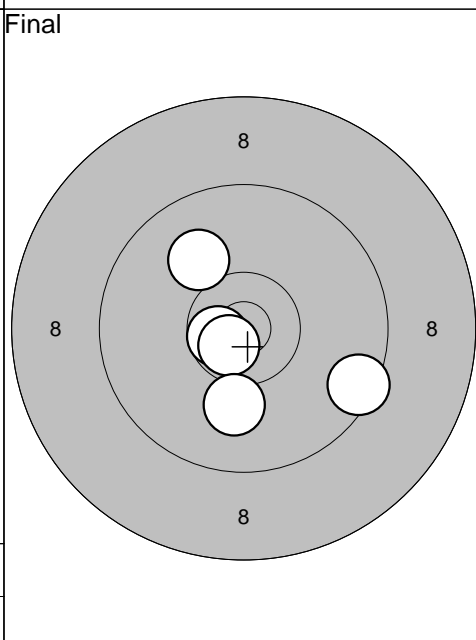

11: 10,0	↖
12: 10,6*	←
13: 10,7*	↙
14: 9,5	→
15: 10,1	↓
Serie: 49,0	
Summa: 308,0	

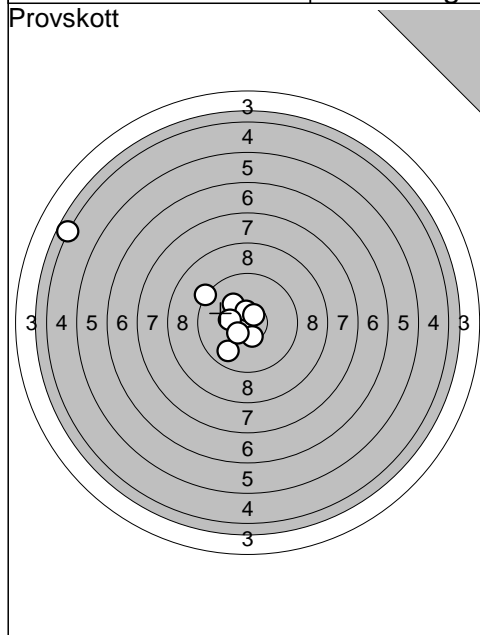

1: 4,3	↖
2: 9,8	↙
3: 10,2	↗
4: 10,7*	↖
5: 10,6*	↑
6: 10,4*	↖
7: 10,5*	↘
8: 9,3	↗
9: 10,5*	↙
10: 10,6*	↗
Serie:	92,0
Summa:	0,0

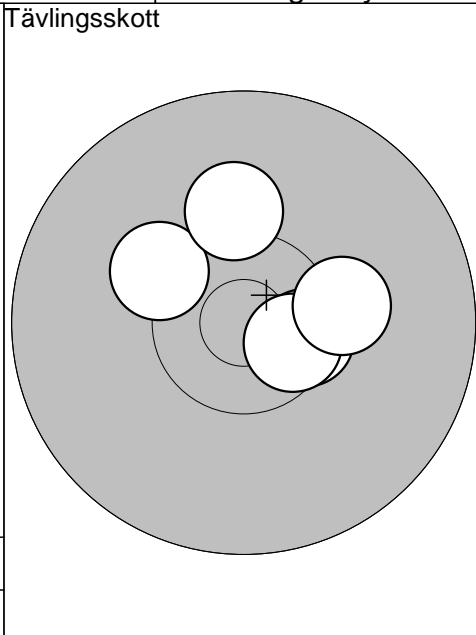

1: 10,3	↖
2: 10,5*	→
3: 10,6*	→
4: 10,2	↑
5: 10,2	→
Serie:	50,0
Summa:	50,0

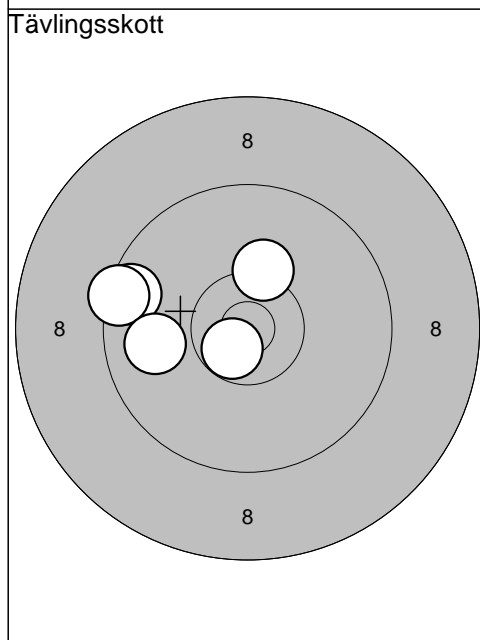

6: 9,6	↖
7: 9,4	↖
8: 9,9	↖
9: 10,3	↑
10: 10,7*	↙
Serie:	47,0
Summa:	97,0

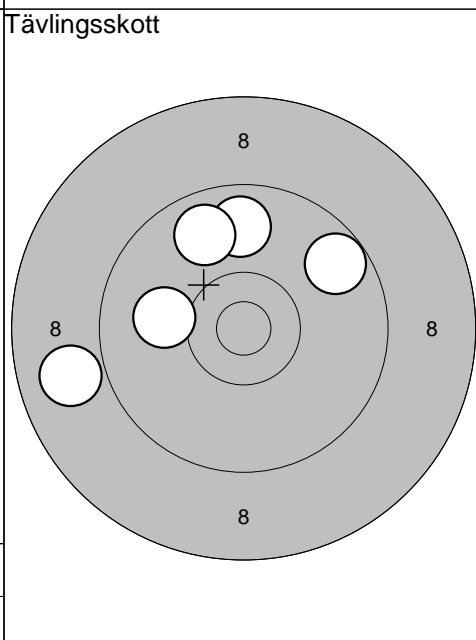

11: 8,9	↖
12: 9,8	↑
13: 10,0	↖
14: 9,7	↗
15: 9,8	↑
Serie:	45,0
Summa:	142,0

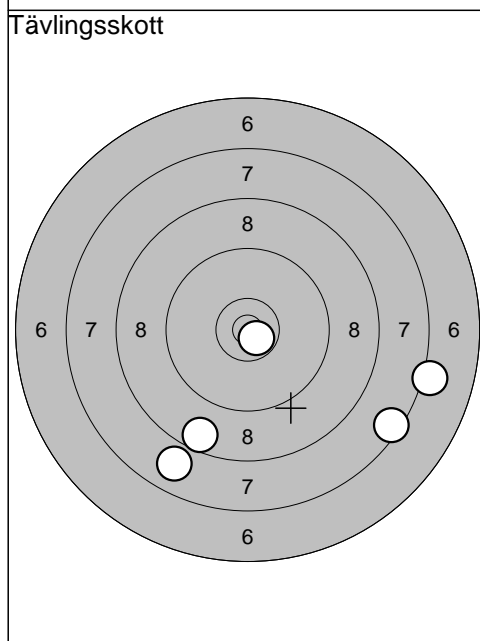

16: 7,9	↙
17: 7,5	↘
18: 10,7*	↘
19: 7,2	→
20: 8,6	↙
Serie:	39,0
Summa:	181,0

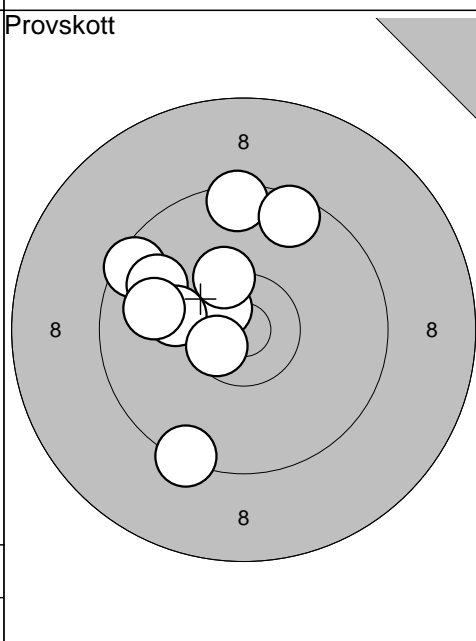

1: 9,4	↙
2: 9,5	↖
3: 9,8	↖
4: 9,5	↑
5: 10,6*	↖
6: 10,2	↖
7: 10,6*	↖
8: 9,9	↖
9: 9,6	↑
10: 10,3*	↑
Serie:	94,0
Summa:	181,0

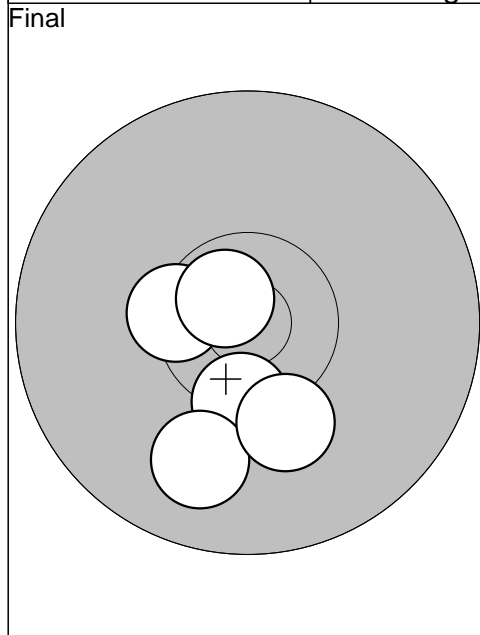

1: 10,4*	←
2: 10,4*	↓
3: 9,9	↓
4: 10,7*	↗
5: 10,2	↓
Serie: 49,0	
Summa: 230,0	

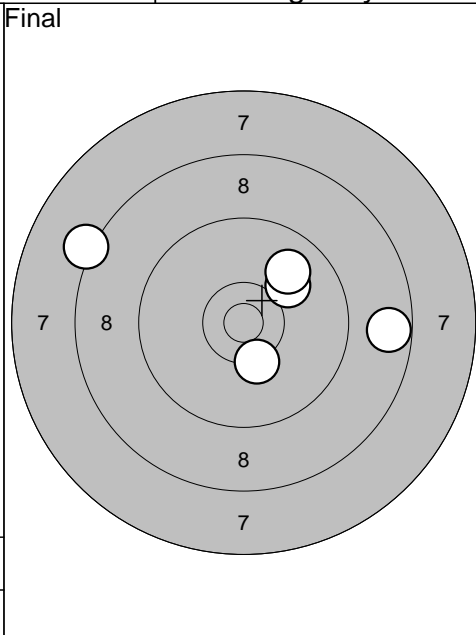

6: 8,2	↖
7: 8,7	→
8: 10,0	↗
9: 10,3*	↓
10: 9,9	↗
Serie: 45,0	
Summa: 275,0	

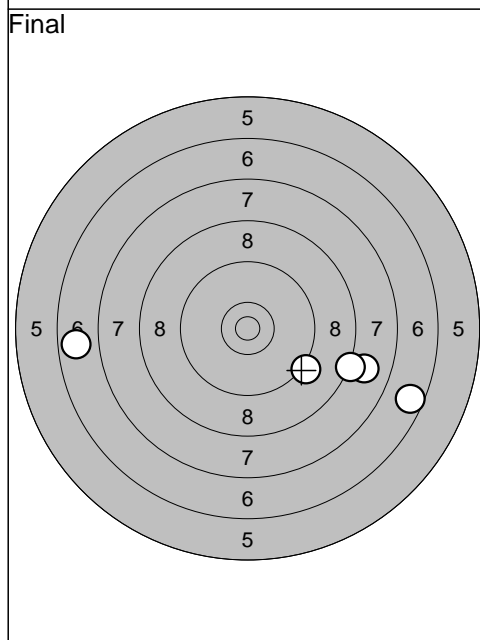

11: 7,9	→
12: 6,8	←
13: 6,6	→
14: 9,2	↓
15: 8,3	↘
Serie: 36,0	
Summa: 311,0	

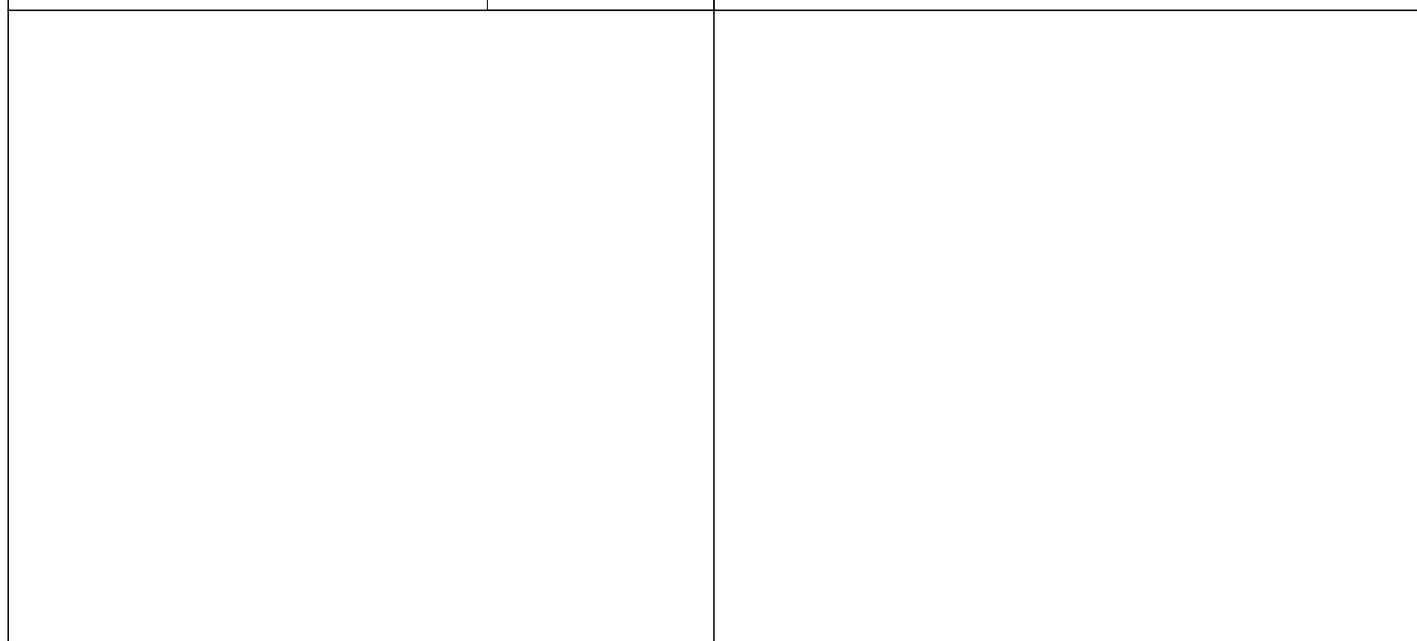

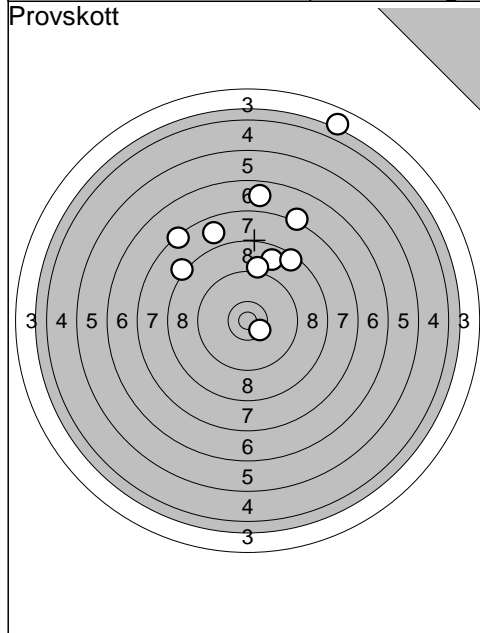

1: 3,8	↗
2: 7,2	↗
3: 8,2	↖
4: 7,4	↗
5: 7,9	↗
6: 6,8	↗
7: 8,8	↗
8: 9,2	↗
9: 8,5	↗
10: 10,4*	↘
Serie:	73,0
Summa:	0,0

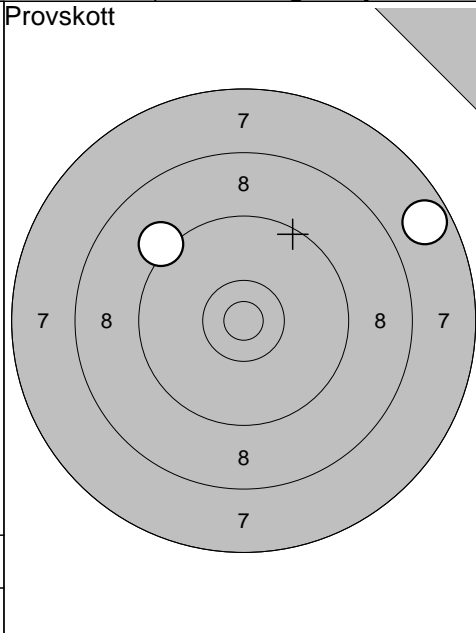

11: 7,7	↗
12: 9,2	↖
Serie:	16,0
Summa:	0,0

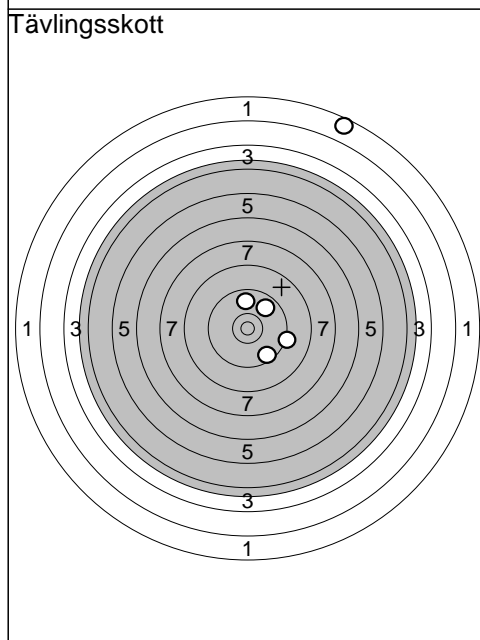

1: 9,8	↗
2: 1,6	↗
3: 9,6	↘
4: 9,2	→
5: 9,8	↗
Serie:	37,0
Summa:	37,0

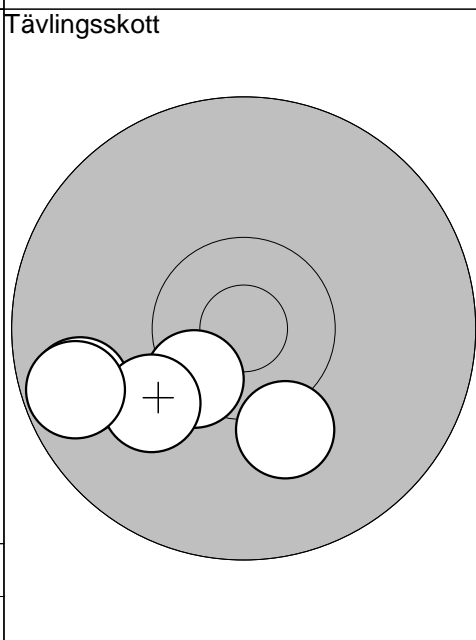

6: 9,7	↖
7: 10,4*	↖
8: 10,2	↘
9: 10,1	↖
10: 9,7	↖
Serie:	48,0
Summa:	85,0

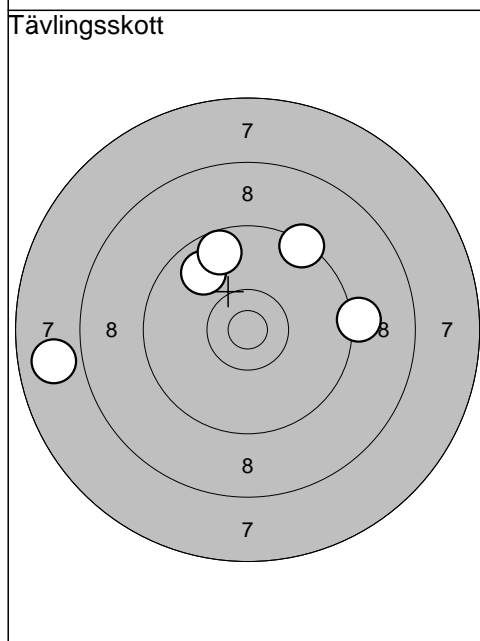

11: 9,8	↖
12: 9,2	→
13: 9,7	↗
14: 7,9	↖
15: 9,4	↗
Serie:	43,0
Summa:	128,0

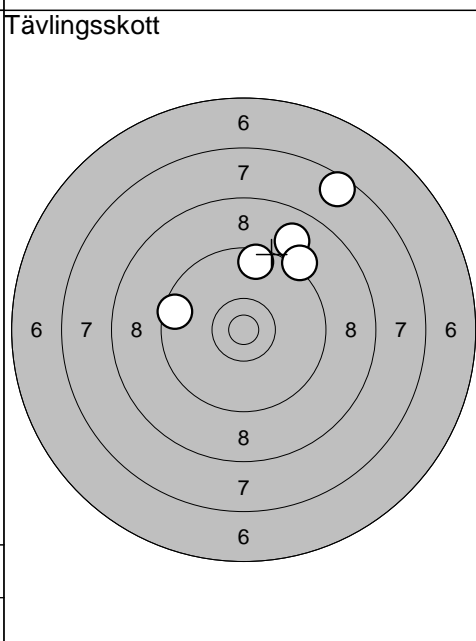

16: 8,9	↗
17: 9,2	↗
18: 9,5	↖
19: 7,6	↗
20: 9,6	↗
Serie:	42,0
Summa:	170,0

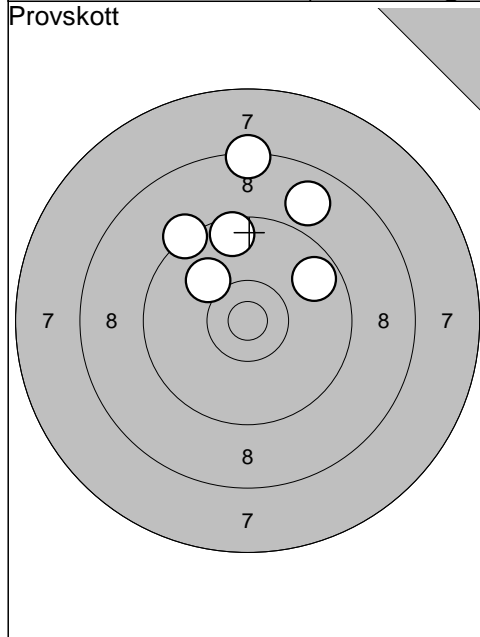

1: 9,3 ↖
2: 8,9 ↗
3: 9,6 ↑
4: 9,7 ↗
5: 8,4 ↑
6: 10,1 ↖
Serie: 53,0
Summa: 170,0

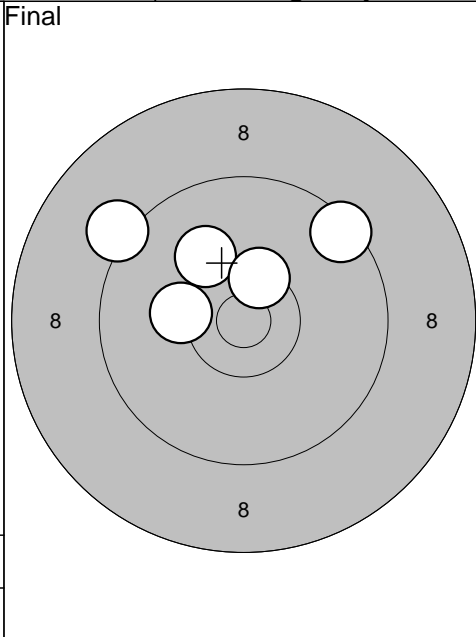

1: 10,1 ↖
2: 10,2 ←
3: 9,5 ↗
4: 10,4* ↑
5: 9,2 ↖
Serie: 48,0
Summa: 218,0

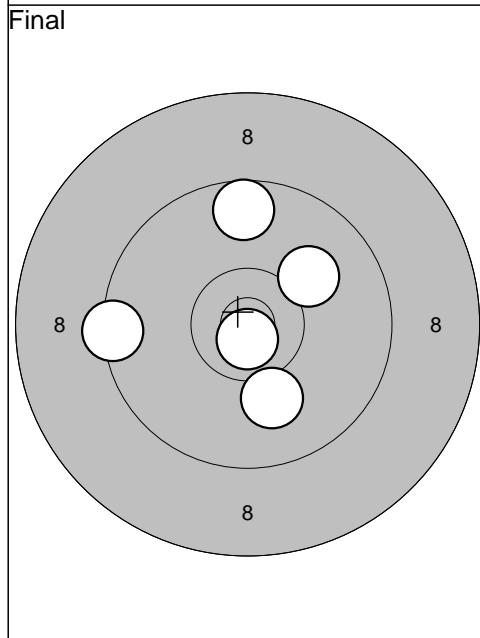

6: 9,6 ↑
7: 10,8* ↓
8: 9,4 ←
9: 10,1 ↗
10: 10,1 ↓
Serie: 48,0
Summa: 266,0

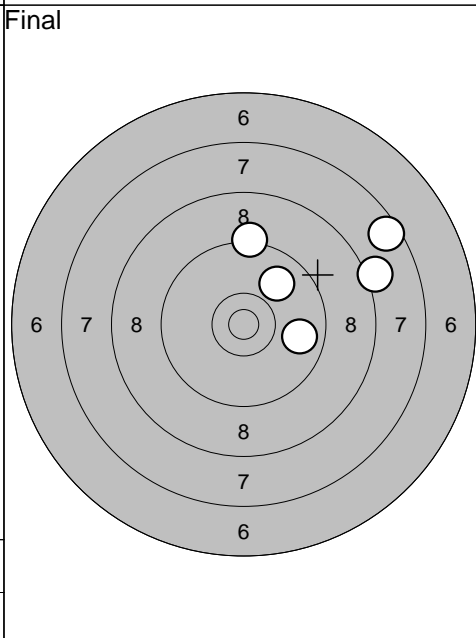

11: 9,9 ↗
12: 7,6 ↗
13: 8,1 ↗
14: 9,8 →
15: 9,3 ↑
Serie: 42,0
Summa: 308,0

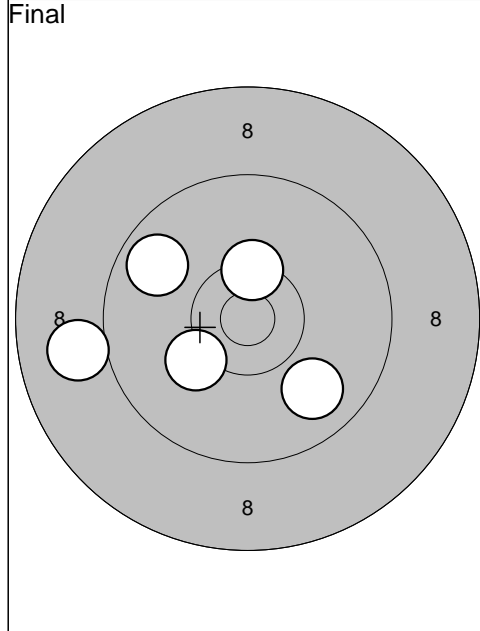

1: 10,2	↙
2: 9,0	←
3: 9,8	↖
4: 9,9	↘
5: 10,4*	↑
<hr/>	
Serie:	47,0
Summa:	235,0

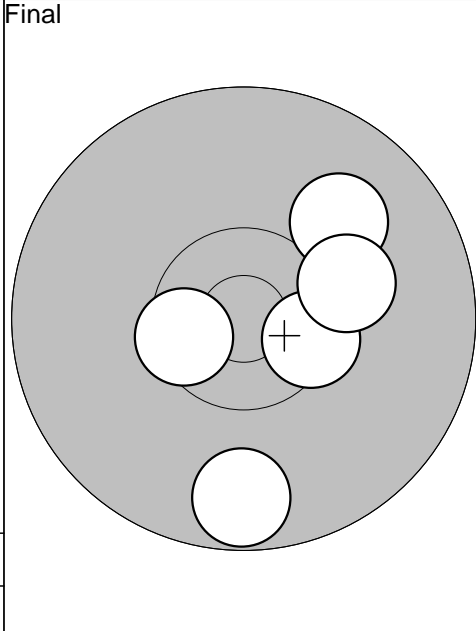

6: 9,7	↓
7: 10,4*	→
8: 10,0	↗
9: 10,2	→
10: 10,5*	←
<hr/>	
Serie:	49,0
Summa:	284,0

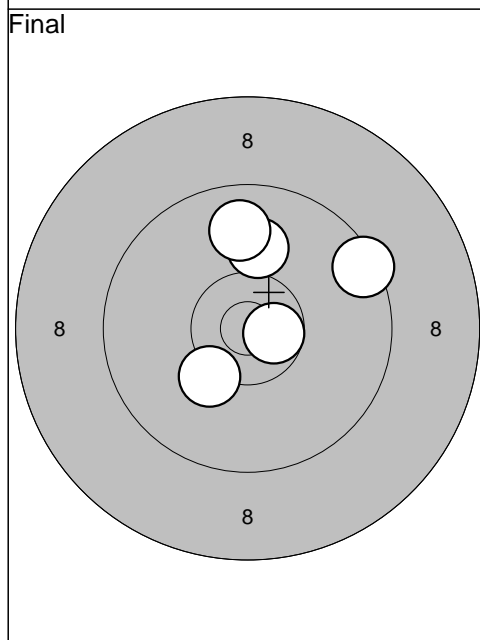

11: 10,6*	→
12: 10,3	↙
13: 10,0	↑
14: 9,8	↑
15: 9,5	↗
<hr/>	
Serie:	48,0
Summa:	332,0

--	--

Provskott

1: 8,5	↗
2: 8,5	↑
3: 8,4	←
4: 10,0	↓
5: 10,3*	↙
6: 8,9	↓
7: 8,9	↘
8: 9,8	↑
9: 9,3	↑
10: 10,1	↙
Serie:	88,0
Summa:	0,0

Provskott

11: 9,4	↘
12: 10,4*	←
13: 9,6	↖
14: 9,5	↓
15: 10,2	↗
Serie:	47,0
Summa:	0,0

Tävlingsskott

1: 10,5*	↘
2: 9,5	↓
3: 9,6	↓
4: 10,0	↑
5: 9,8	↖
Serie:	47,0
Summa:	47,0

Tävlingsskott

6: 9,5	→
7: 9,9	→
8: 9,5	↘
9: 9,6	↖
10: 9,7	↓
Serie:	45,0
Summa:	92,0

Tävlingsskott

11: 10,4*	←
12: 9,7	←
13: 10,6*	↗
14: 9,8	↖
15: 9,6	↑
Serie:	47,0
Summa:	139,0

Tävlingsskott

16: 9,3	←
17: 10,0	↗
18: 9,6	→
19: 9,7	↑
20: 10,2	↖
Serie:	47,0
Summa:	186,0

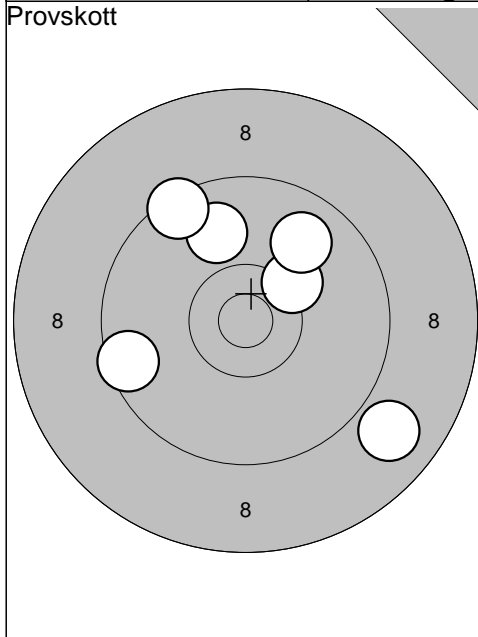

1: 10,3	↗
2: 9,9	↑
3: 9,5	↖
4: 9,5	←
5: 9,9	↗
6: 8,9	↘

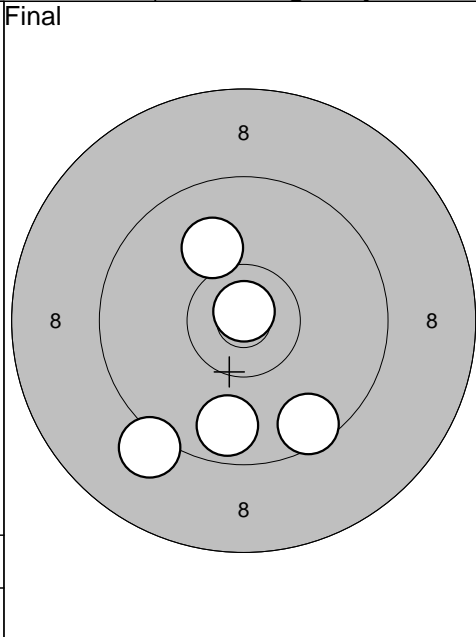

1: 9,6	↘
2: 9,2	↙
3: 10,1	↖
4: 10,8*	↑
5: 9,7	↘

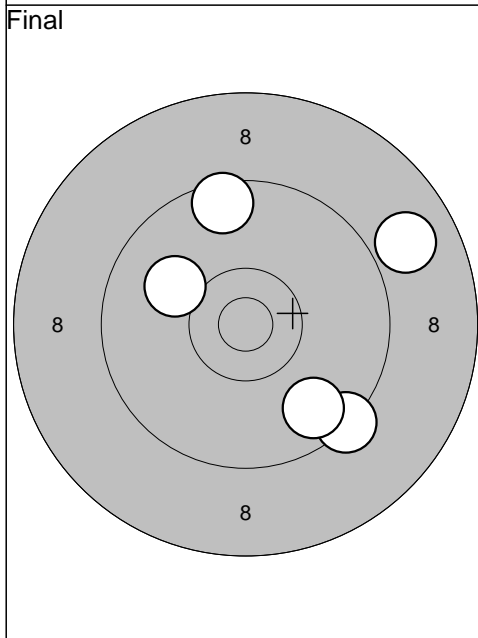

6: 10,0	↖
7: 9,3	↘
8: 9,7	↘
9: 9,5	↑
10: 8,9	↗

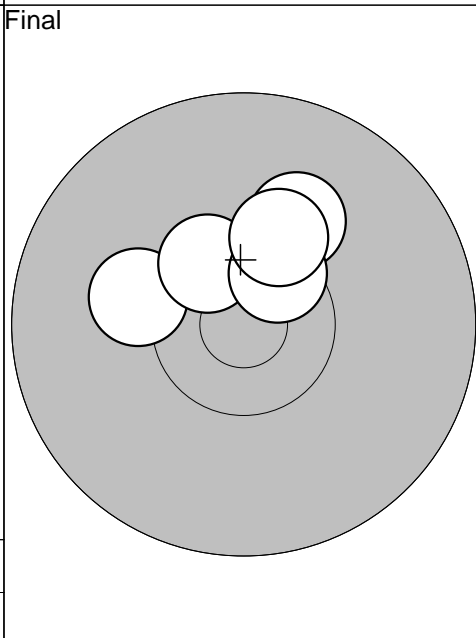

11: 10,2	←
12: 10,5*	↖
13: 10,1	↗
14: 10,5*	↗
15: 10,3	↗

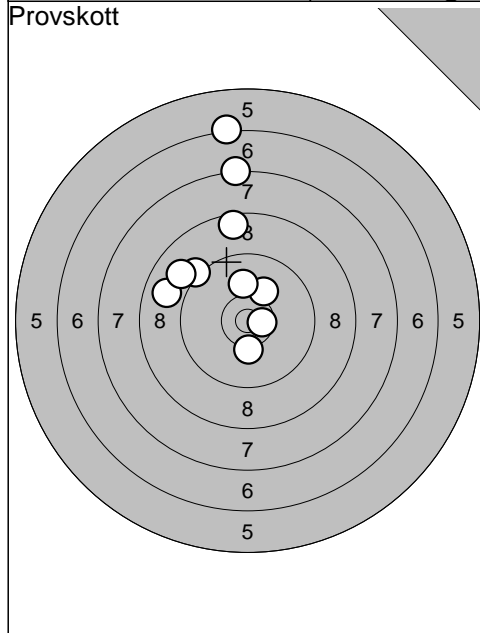

1: 7,3	↑
2: 6,3	↑
3: 10,6*	→
4: 9,2	↖
5: 8,6	↑
6: 8,9	↖
7: 10,1	↗
8: 9,0	↖
9: 10,2	↓
10: 10,1	↑
Serie:	87,0
Summa:	0,0

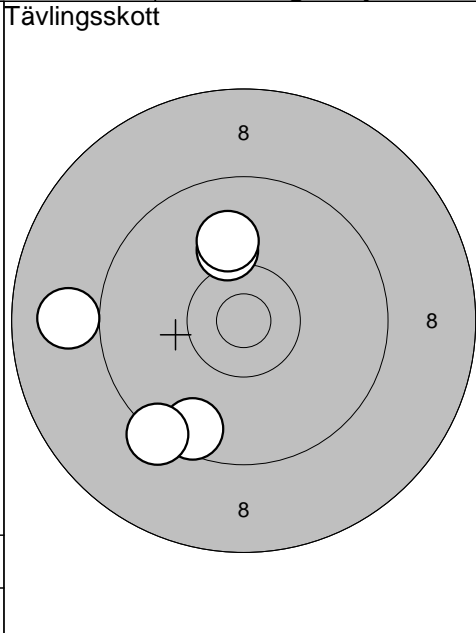

1: 10,1	↑
2: 9,0	←
3: 9,6	↘
4: 9,3	↘
5: 10,0	↑
Serie:	47,0
Summa:	47,0

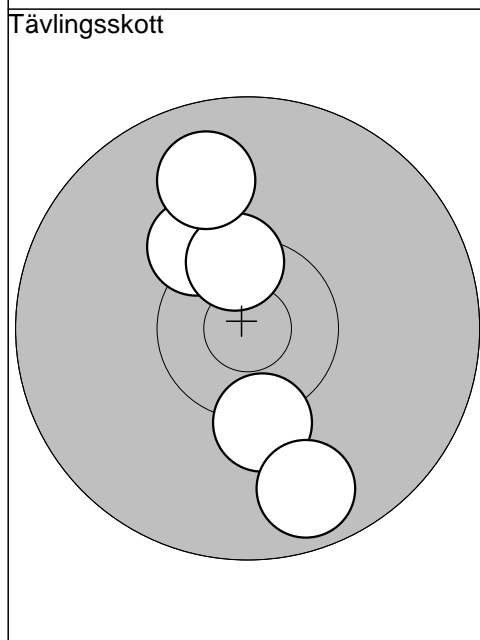

6: 10,3	↓
7: 10,3	↖
8: 10,5*	↑
9: 9,9	↑
10: 9,7	↓
Serie:	48,0
Summa:	95,0

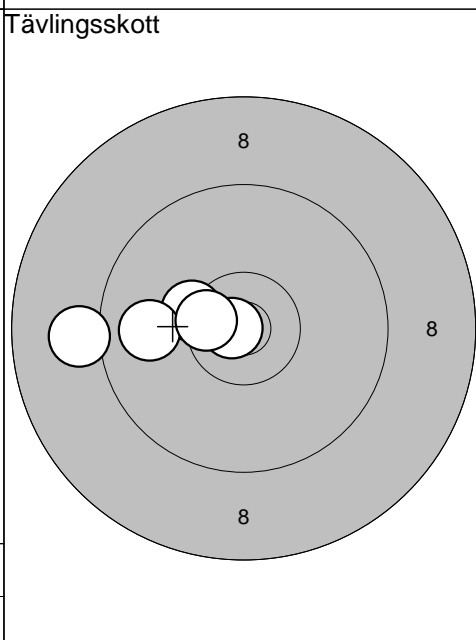

11: 10,3*	←
12: 9,9	←
13: 10,8*	←
14: 10,5*	←
15: 9,1	←
Serie:	48,0
Summa:	143,0

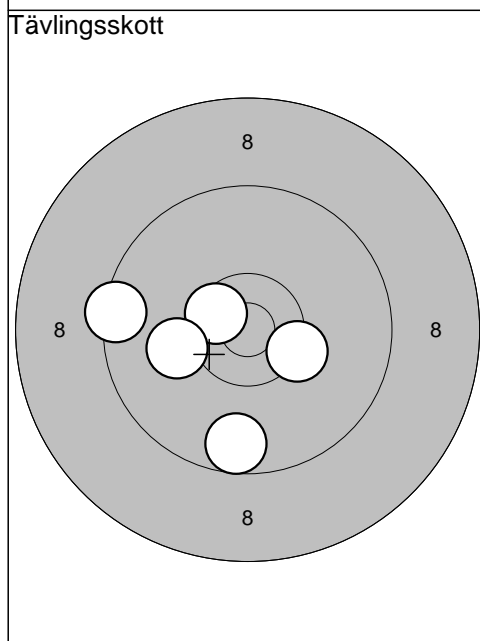

16: 10,5*	↖
17: 10,3*	→
18: 9,4	←
19: 10,1	←
20: 9,6	↓
Serie:	48,0
Summa:	191,0

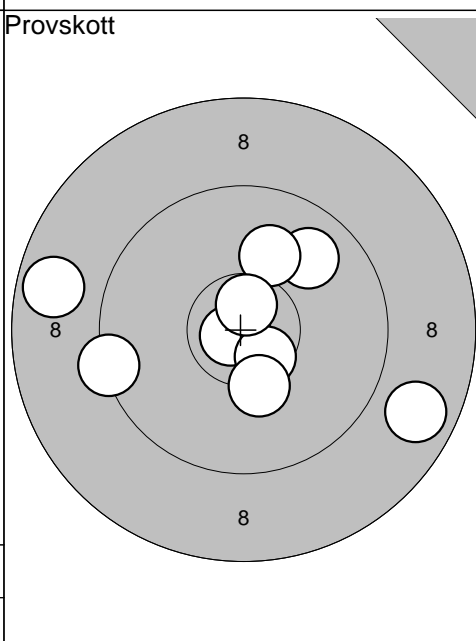

1: 9,4	←
2: 8,8	→
3: 10,8*	←
4: 10,6*	↘
5: 10,3	↓
6: 9,9	↗
7: 8,7	←
8: 10,1	↑
9: 10,7*	↑
Serie:	84,0
Summa:	191,0

Final

1: 10,1 ←
2: 9,0 ↓
3: 9,4 →
4: 9,7 ↘
5: 10,6* ←

Serie:	47,0
Summa:	238,0

Final

6: 8,6 ↓
7: 9,5 ←
8: 8,8 ↓
9: 9,9 ↑
10: 9,2 ↓

Serie:	43,0
Summa:	281,0

Final

11: 9,8 ↘
12: 10,4* ↑
13: 9,4 ↓
14: 10,4* ←
15: 8,9 →

Serie:	46,0
Summa:	327,0

Provskott

1: 9,9	↗
2: 9,0	↑
3: 9,8	↗
4: 10,4*	↓
5: 10,5*	←
Serie: 47,0	
Summa: 0,0	

Tävlingskott

1: 9,9	↑
2: 10,3*	↗
3: 8,0	↑
4: 10,6*	↓
5: 10,1	↑
Serie: 47,0	
Summa: 47,0	

Tävlingskott

6: 9,9	→
7: 10,3*	↗
8: 9,1	↑
9: 10,3*	↓
10: 9,7	↘
Serie: 47,0	
Summa: 94,0	

Tävlingskott

11: 9,0	↘
12: 9,6	↗
13: 9,5	↑
14: 8,8	↘
15: 10,5*	↑
Serie: 45,0	
Summa: 139,0	

Tävlingskott

16: 8,6	↘
17: 9,1	↓
18: 7,5	→
19: 3,7	↓
20: 5,9	↓
Serie: 32,0	
Summa: 171,0	

Provskott

1: 6,1	↓
2: 7,6	↓
3: 8,4	↘
4: 9,4	↘
5: 9,2	↓
6: 6,1	↑
7: 9,9	↗
8: 8,7	↗
9: 10,0	↗
Serie: 72,0	
Summa: 171,0	

Final

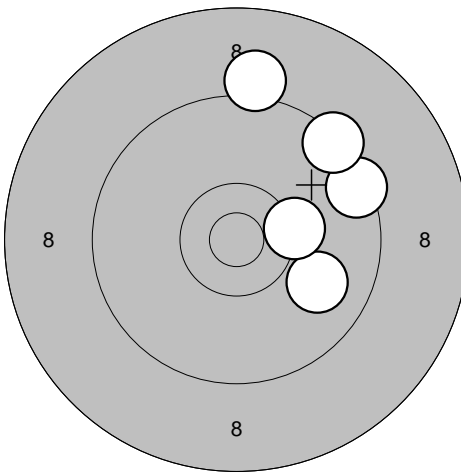

Serie:	46,0
Summa:	217,0

- 1: 9,5 →
- 2: 9,4 ↗
- 3: 9,1 ↑
- 4: 9,9 →
- 5: 10,3 →

Final

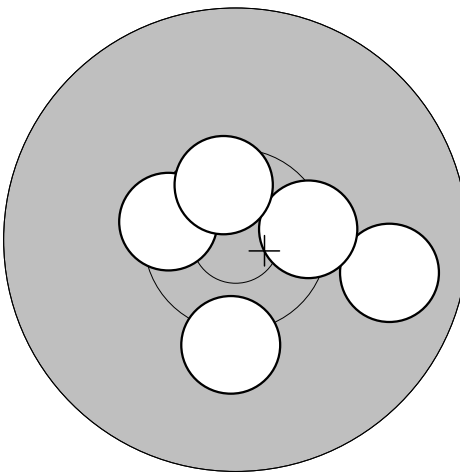

Serie:	49,0
Summa:	266,0

- 6: 9,8 →
- 7: 10,2 ↓
- 8: 10,4* →
- 9: 10,5* ←
- 10: 10,6* ↑

Final

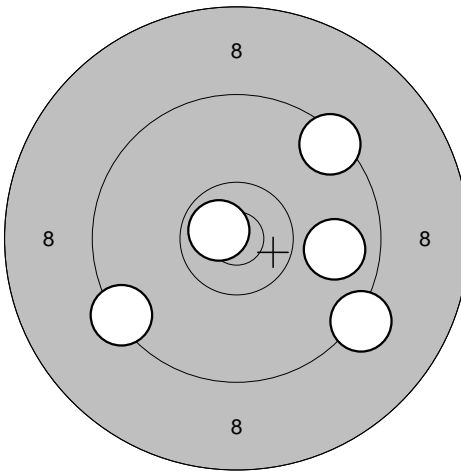

Serie:	46,0
Summa:	312,0

- 11: 9,4 ↙
- 12: 9,4 ↗
- 13: 9,2 →
- 14: 9,8 →
- 15: 10,7* ↙

--	--

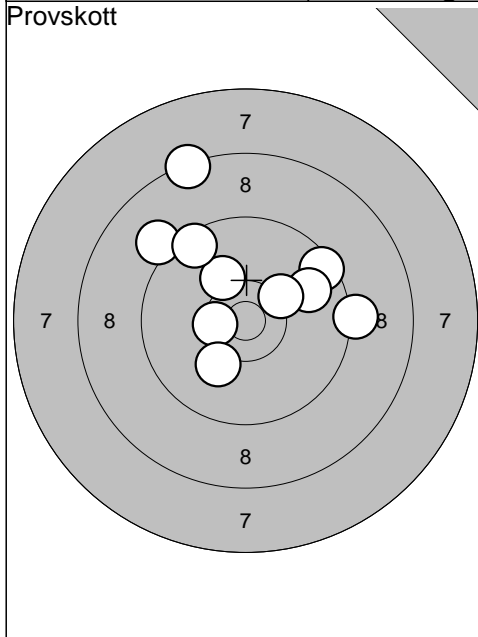

1: 9,5	↗
2: 9,8	→
3: 9,1	↖
4: 10,2	↗
5: 10,5*	←
6: 9,5	↗
7: 8,4	↗
8: 9,2	→
9: 10,1	↘
10: 10,3	↗
Serie:	93,0
Summa:	0,0

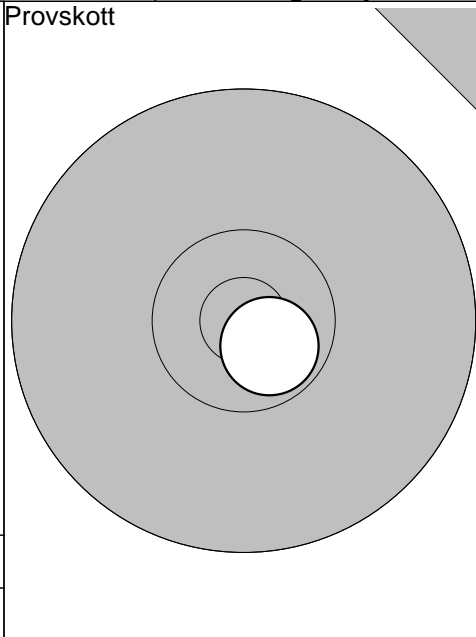

11: 10,7*	↘
Serie:	10,0
Summa:	0,0

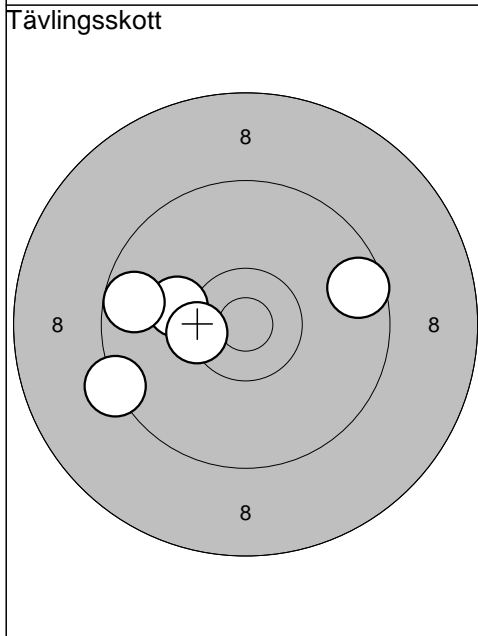

1: 9,3	←
2: 10,2	←
3: 10,4*	←
4: 9,6	→
5: 9,7	←
Serie:	47,0
Summa:	47,0

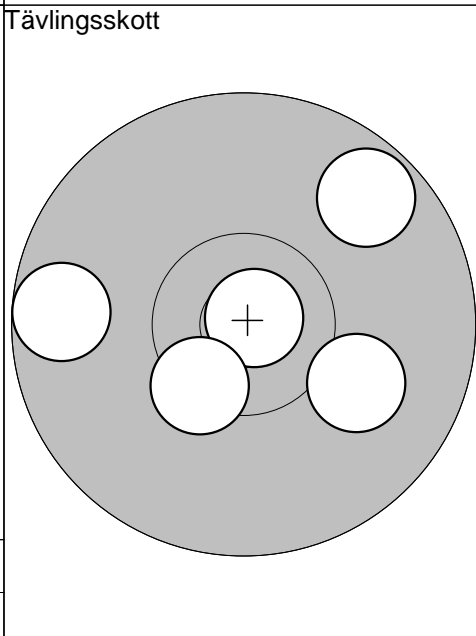

6: 9,7	←
7: 10,9*	↗
8: 9,7	↗
9: 10,0	→
10: 10,4*	↘
Serie:	48,0
Summa:	95,0

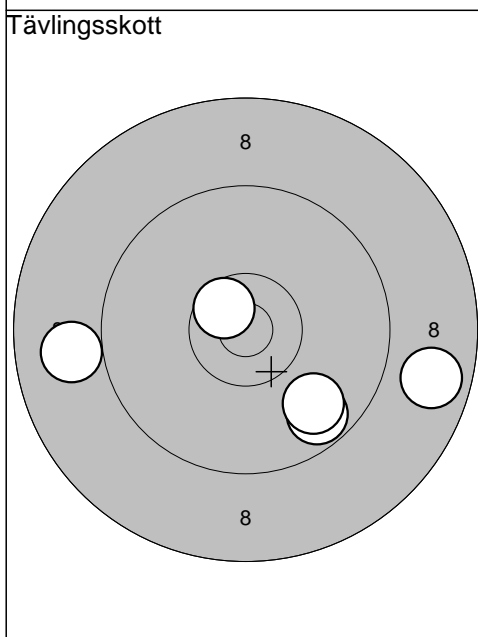

11: 9,0	←
12: 9,7	↘
13: 9,8	↘
14: 8,8	→
15: 10,6*	↗
Serie:	45,0
Summa:	140,0

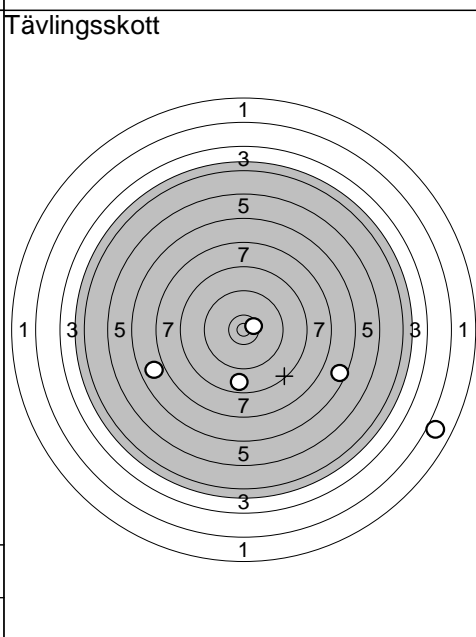

16: 8,8	↓
17: 6,6	→
18: 10,5*	↗
19: 2,0	→
20: 6,9	←
Serie:	32,0
Summa:	172,0

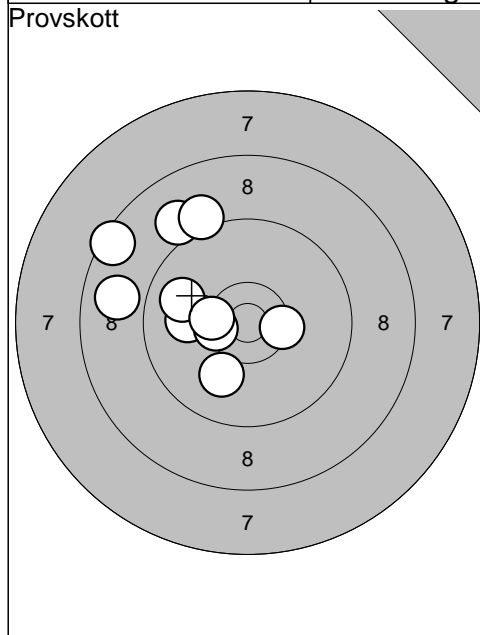

1: 10,0	↙
2: 10,4*	→
3: 9,0	↗
4: 8,9	←
5: 9,1	↗
6: 8,5	↗
7: 10,0	←
8: 9,9	↗
9: 10,4*	←
10: 10,4*	←
Serie: 93,0	
Summa: 172,0	

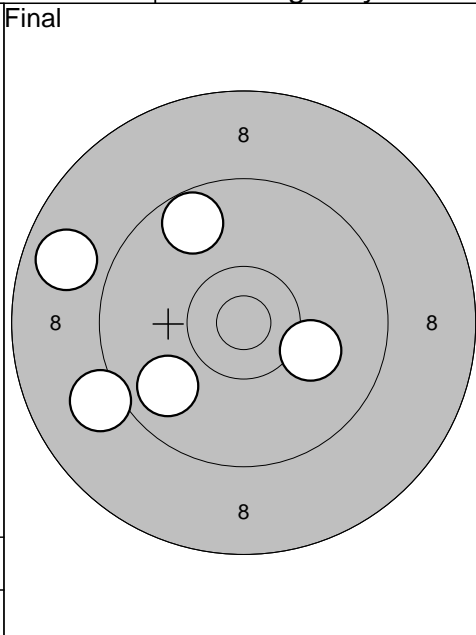

1: 10,1	→
2: 9,8	↙
3: 9,1	↙
4: 8,8	↙
5: 9,7	↗
Serie: 45,0	
Summa: 217,0	

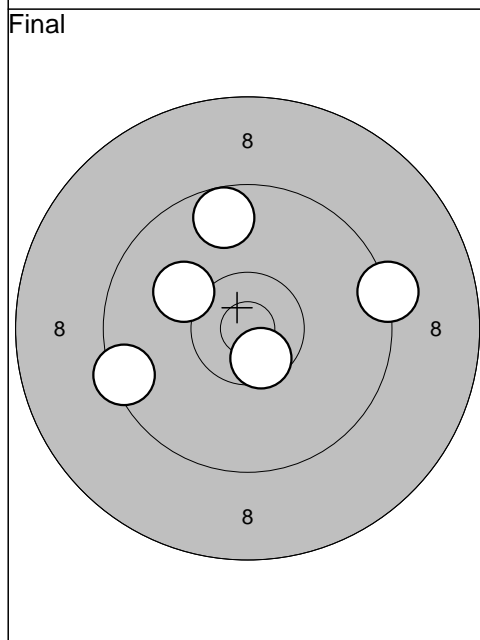

6: 10,6*	↙
7: 9,4	←
8: 10,1	↗
9: 9,7	↗
10: 9,3	→
Serie: 47,0	
Summa: 264,0	

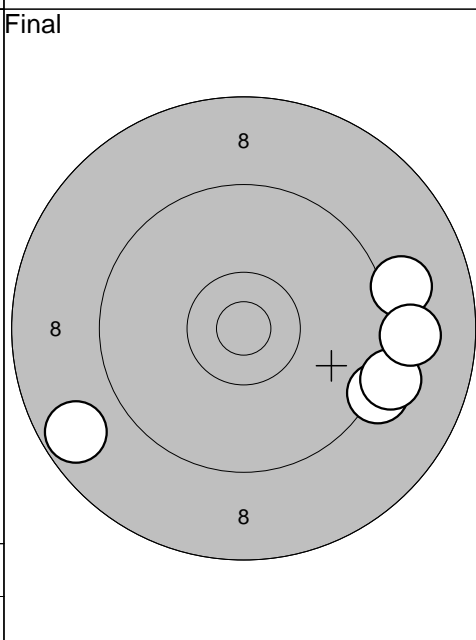

11: 8,7	↙
12: 9,2	→
13: 9,1	→
14: 9,2	→
15: 9,0	→
Serie: 44,0	
Summa: 308,0	

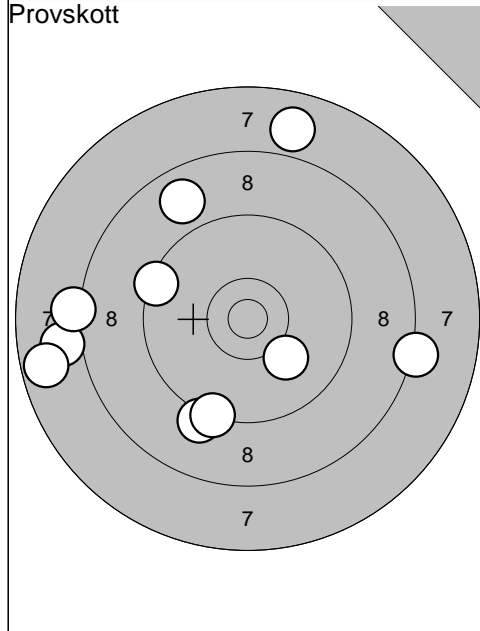

1: 8,0	←
2: 9,2	↙
3: 8,8	↗
4: 7,7	←
5: 9,3	↙
6: 8,2	←
7: 10,1	↙
8: 8,2	→
9: 9,4	↖
10: 7,9	↑
Serie:	83,0
Summa:	0,0

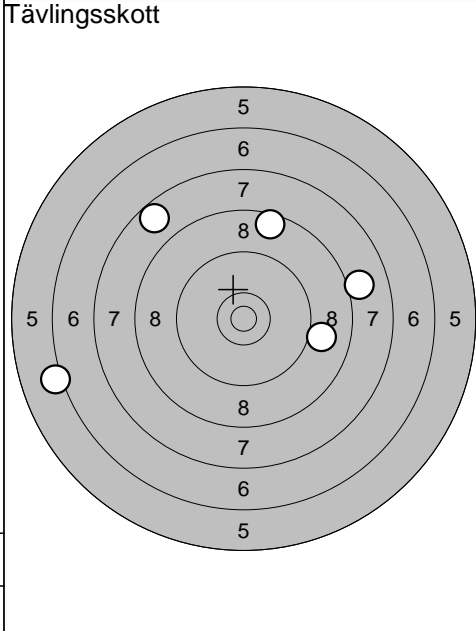

1: 7,7	↖
2: 8,6	↑
3: 9,0	→
4: 8,0	→
5: 6,1	←
Serie:	38,0
Summa:	38,0

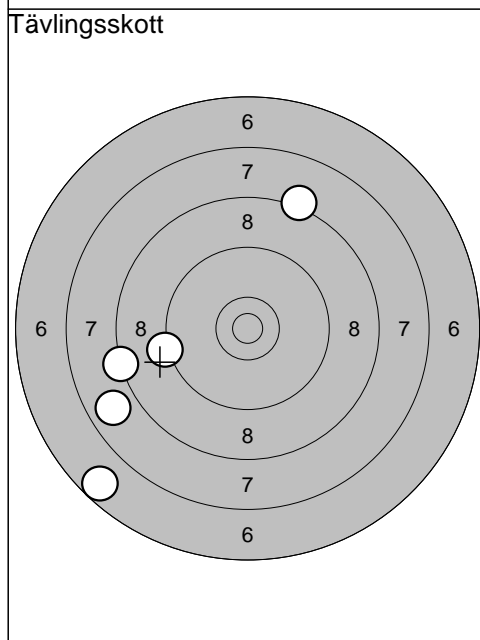

6: 9,2	←
7: 7,8	↙
8: 8,2	↗
9: 8,3	←
10: 6,7	↙
Serie:	38,0
Summa:	76,0

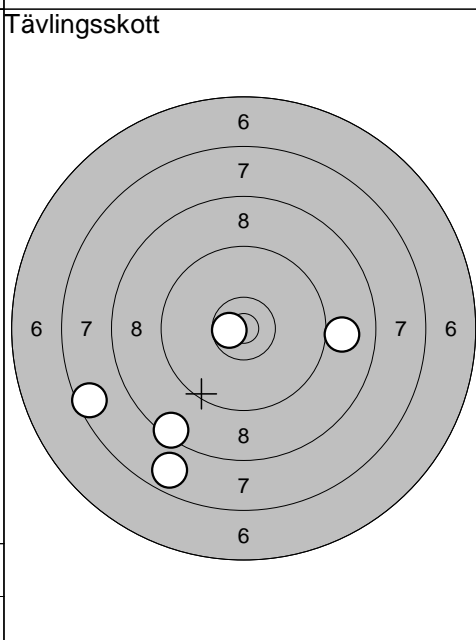

11: 9,0	→
12: 8,4	↙
13: 7,6	←
14: 7,7	↙
15: 10,7*	←
Serie:	41,0
Summa:	117,0

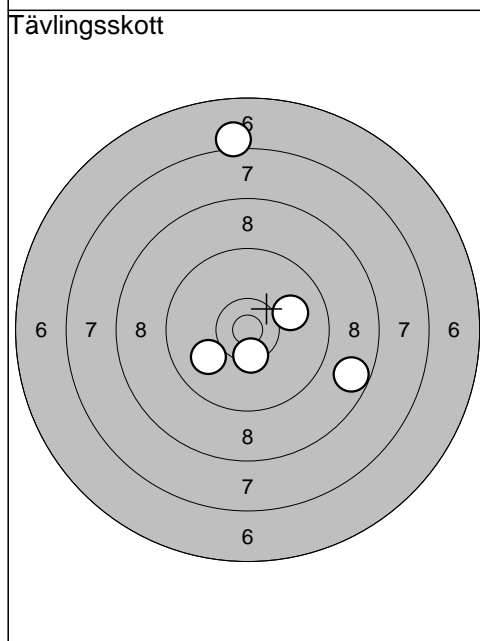

16: 8,7	→
17: 10,0	→
18: 10,0	↙
19: 10,4*	↙
20: 7,1	↑
Serie:	45,0
Summa:	162,0

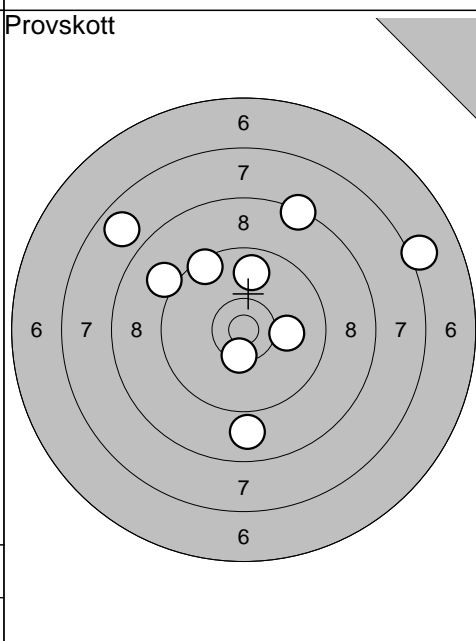

1: 10,1	→
2: 7,1	→
3: 8,9	↓
4: 8,4	↗
5: 7,8	↖
6: 9,1	↖
7: 9,5	↗
8: 10,4*	↓
9: 9,8	↑
Serie:	77,0
Summa:	162,0

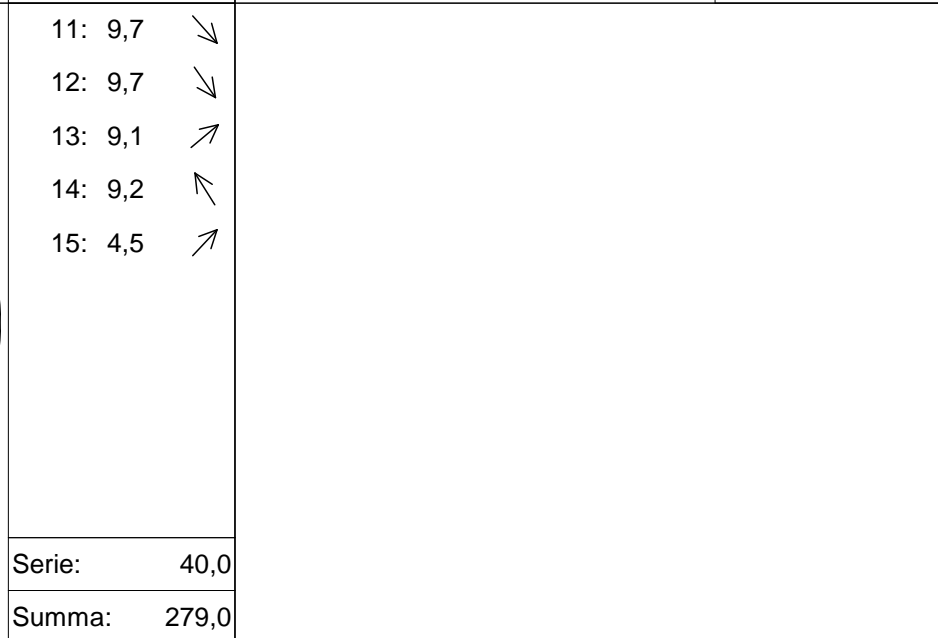
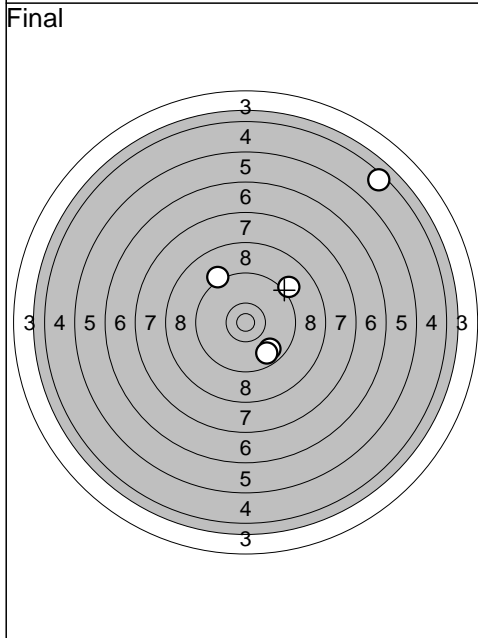
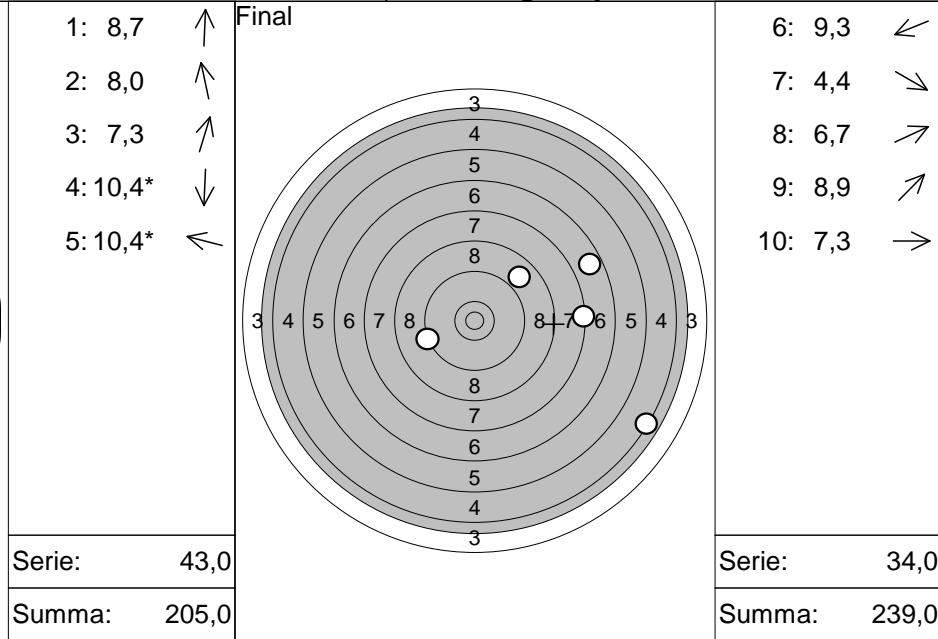
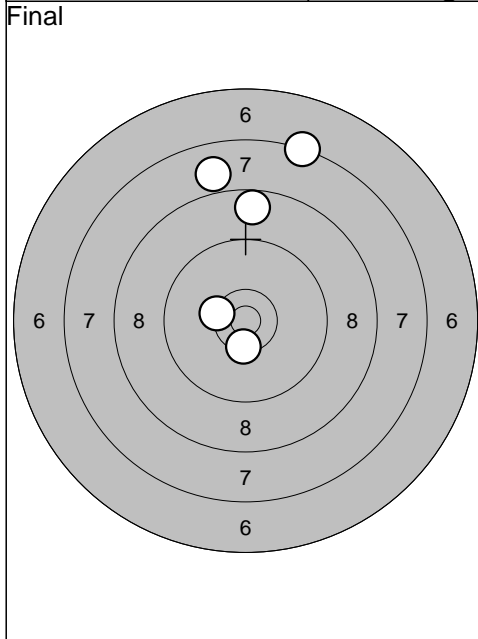

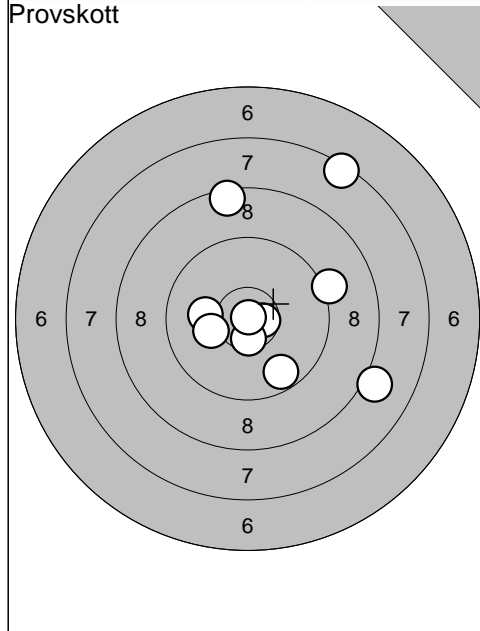

1: 8,5	↑
2: 10,1	←
3: 9,2	→
4: 10,6*	→
5: 7,4	↗
6: 10,5*	↓
7: 10,2	←
8: 10,9*	↗
9: 8,1	→
10: 9,7	↘
Serie:	91,0
Summa:	0,0

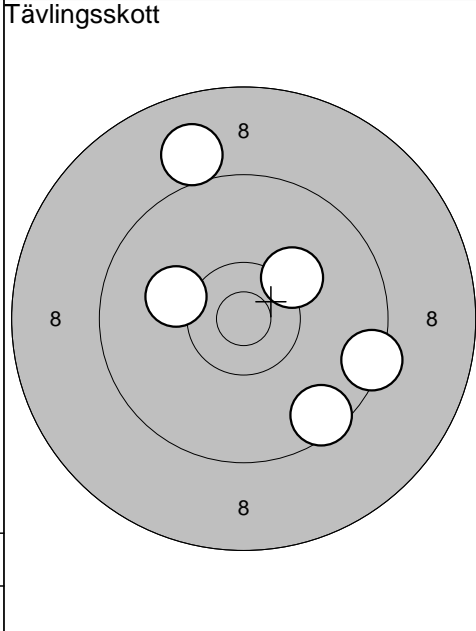

1: 10,2	↗
2: 9,0	↑
3: 9,5	↘
4: 9,4	→
5: 10,1	←
Serie:	47,0
Summa:	47,0

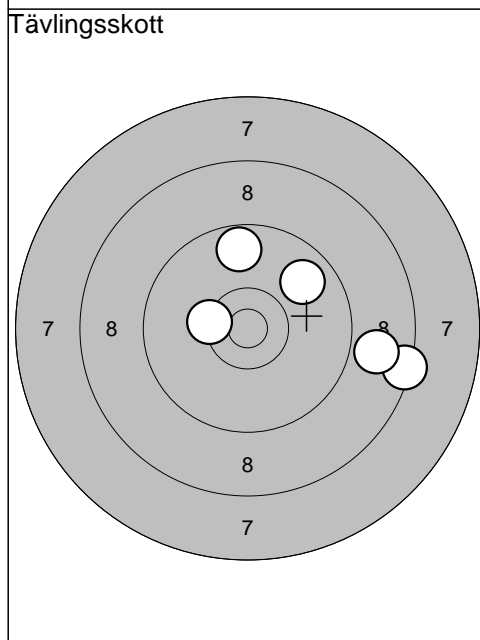

6: 9,8	↗
7: 10,4*	←
8: 8,4	→
9: 9,7	↑
10: 8,9	→
Serie:	44,0
Summa:	91,0

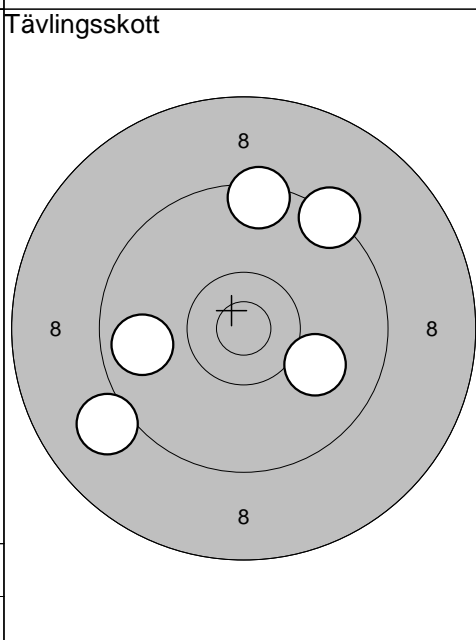

11: 9,0	↙
12: 9,8	←
13: 9,4	↗
14: 9,5	↑
15: 10,0	↘
Serie:	46,0
Summa:	137,0

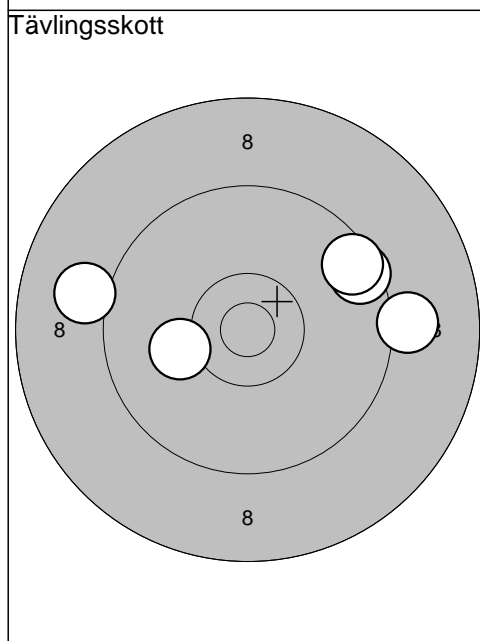

16: 10,2	←
17: 9,1	→
18: 9,5	↗
19: 9,0	←
20: 9,5	↗
Serie:	46,0
Summa:	183,0

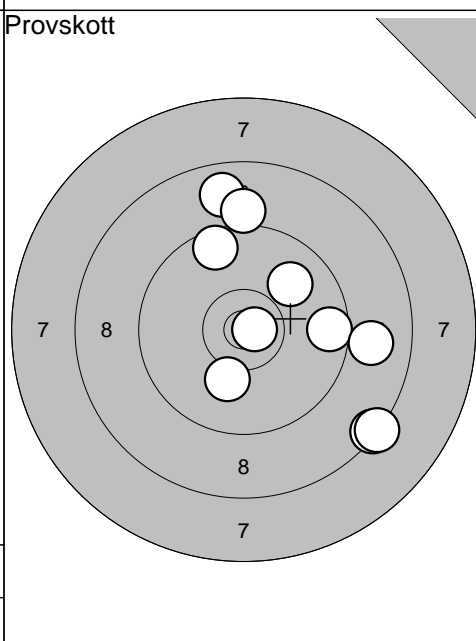

1: 8,4	↘
2: 9,6	→
3: 8,3	↘
4: 9,6	↑
5: 8,8	↑
6: 9,1	↑
7: 8,9	→
8: 10,8*	→
9: 9,9	↗
10: 10,1	↓
Serie:	88,0
Summa:	183,0

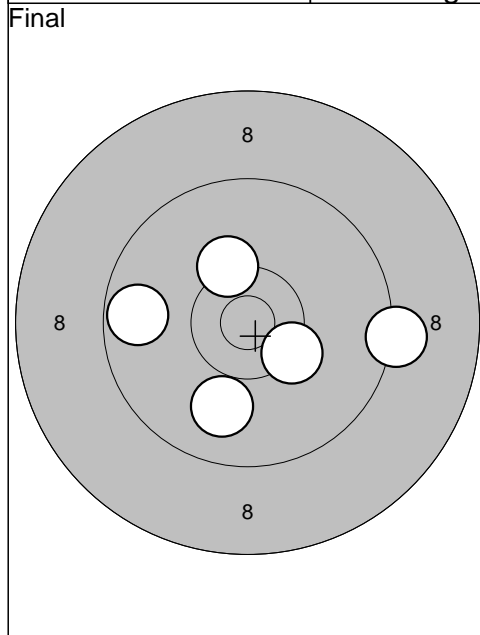

1: 10,3	↖
2: 9,7	←
3: 10,3*	↘
4: 9,9	↓
5: 9,2	→
Serie: 47,0	
Summa: 230,0	

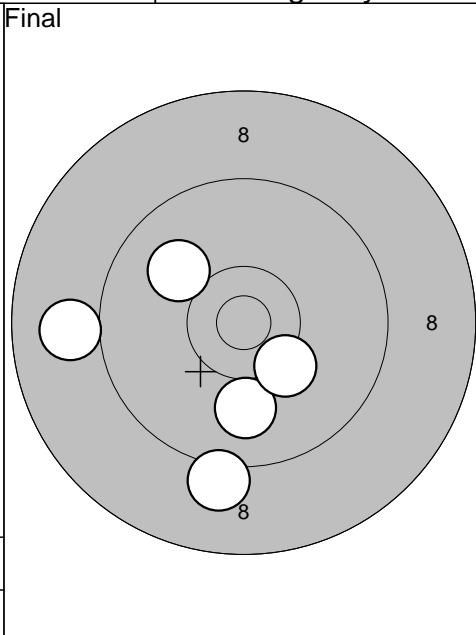

6: 10,0	↓
7: 10,3	↘
8: 9,0	←
9: 9,1	↓
10: 10,0	↖
Serie: 48,0	
Summa: 278,0	

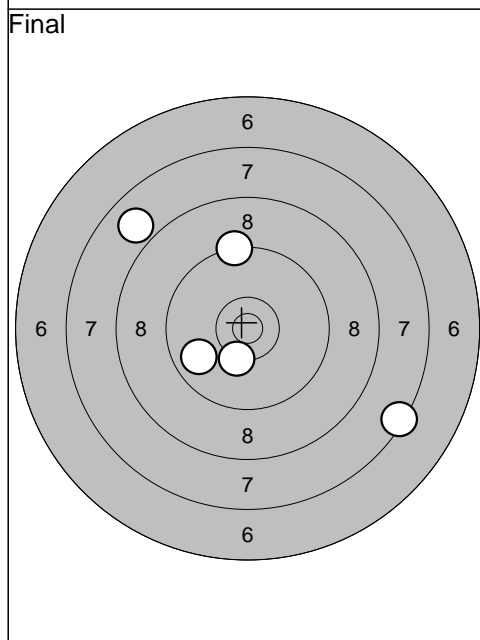

11: 7,9	↖
12: 10,3*	↓
13: 7,4	↘
14: 9,3	↑
15: 9,8	↙
Serie: 42,0	
Summa: 320,0	

--	--

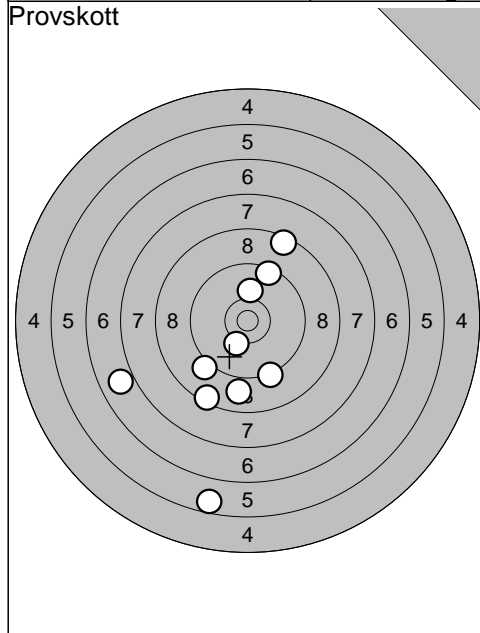

1: 8,5	↙
2: 6,9	←
3: 5,6	↓
4: 9,1	↙
5: 9,3	↓
6: 8,9	↓
7: 10,1	↑
8: 9,5	↗
9: 10,2	↓
10: 8,5	↗
Serie:	82,0
Summa:	0,0

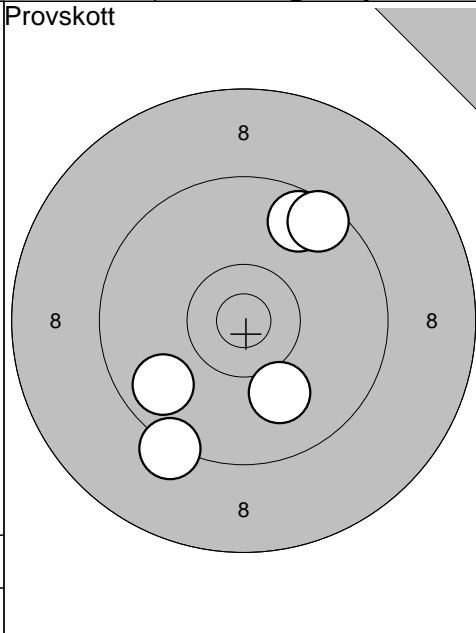

11: 9,8	↙
12: 9,7	↗
13: 9,3	↓
14: 9,5	↗
15: 10,0	↓
Serie:	46,0
Summa:	0,0

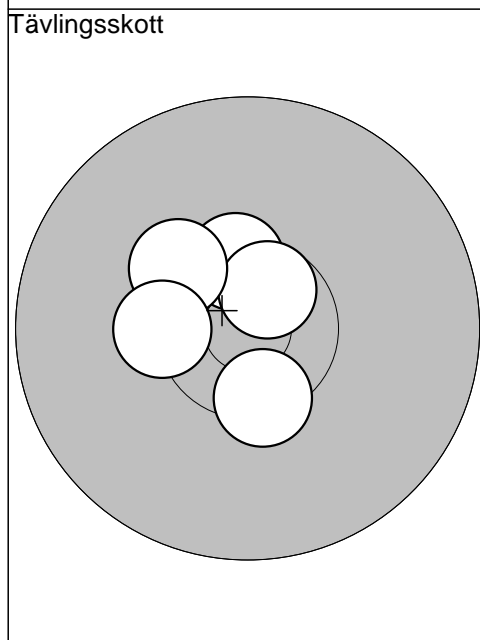

1: 10,5*	↑
2: 10,4*	↓
3: 10,6*	↗
4: 10,3*	↙
5: 10,3*	←
Serie:	50,0
Summa:	50,0

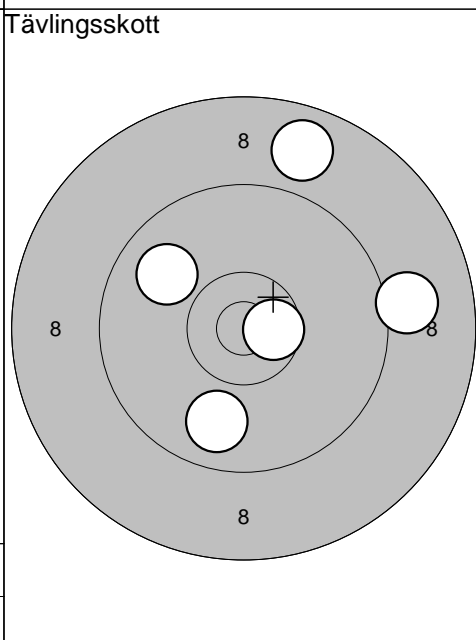

6: 9,1	→
7: 10,6*	→
8: 8,8	↑
9: 9,9	↙
10: 9,8	↓
Serie:	45,0
Summa:	95,0

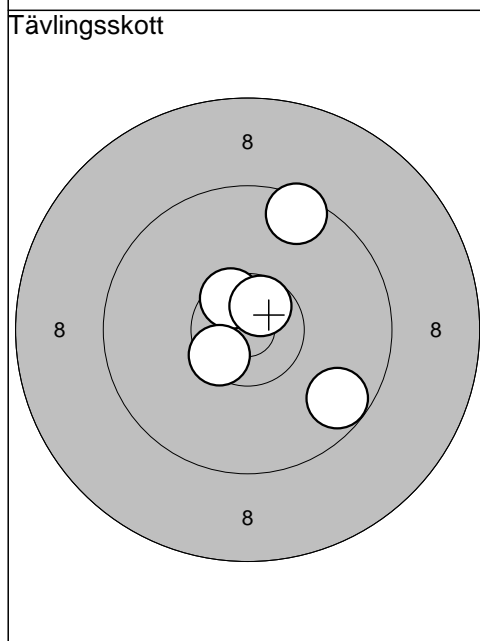

11: 10,5*	↖
12: 9,7	↘
13: 10,6*	↗
14: 10,5*	↙
15: 9,5	↗
Serie:	48,0
Summa:	143,0

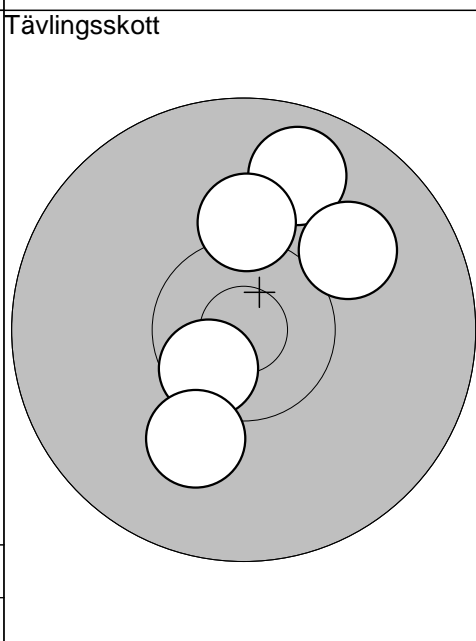

16: 9,8	↗
17: 10,6*	↙
18: 10,0	↗
19: 10,1	↓
20: 10,2	↑
Serie:	49,0
Summa:	192,0

Provskott

1: 9,1	←
2: 10,2	↘
3: 9,6	↗
4: 10,7*	↘
5: 9,8	↙
6: 8,8	↗
7: 9,5	↗
8: 9,8	↑
9: 10,3*	←
10: 10,4*	→
Serie:	93,0
Summa:	192,0

Provskott

11: 9,5	→
12: 10,2	↘
13: 8,9	↗
14: 9,4	↘
15: 10,3*	↘
Serie:	46,0
Summa:	192,0

Final

1: 10,4*	↘
2: 10,5*	↘
3: 10,5*	↘
4: 10,1	→
5: 9,6	←
Serie:	49,0
Summa:	241,0

Final

6: 9,5	↘
7: 10,3*	↗
8: 10,1	↗
9: 9,7	↗
10: 10,0	↖
Serie:	48,0
Summa:	289,0

Final

11: 8,8	↗
12: 10,1	↘
13: 8,8	↘
14: 9,7	↖
15: 9,7	↗
Serie:	44,0
Summa:	333,0

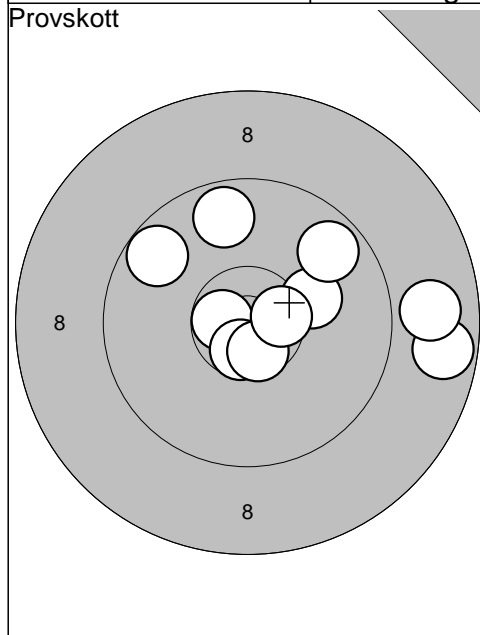

1: 8,7	→
2: 8,9	→
3: 10,2	→
4: 9,7	↑
5: 10,7*	←
6: 9,7	↑
7: 10,6*	↓
8: 9,7	↑
9: 10,6*	↓
10: 10,6*	→
Serie:	93,0
Summa:	0,0

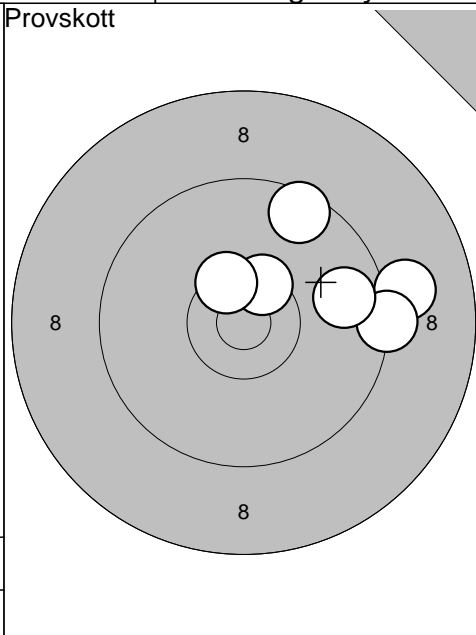

11: 10,5*	↑
12: 9,5	↑
13: 9,1	→
14: 9,3	→
15: 9,8	→
16: 10,5*	↑
Serie:	56,0
Summa:	0,0

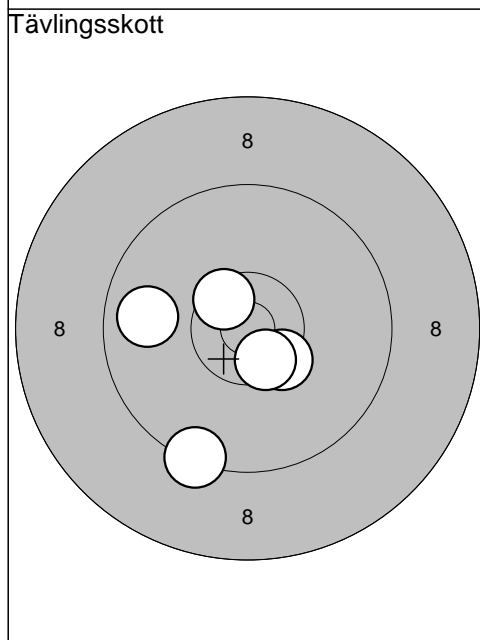

1: 10,4*	↓
2: 10,5*	↓
3: 9,8	←
4: 10,5*	↑
5: 9,4	↓
Serie:	48,0
Summa:	48,0

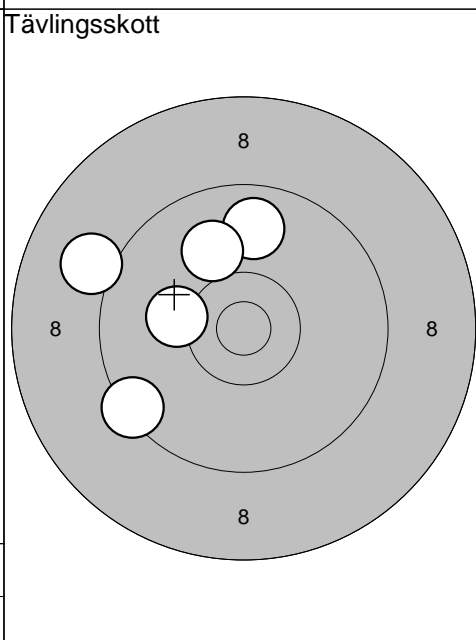

6: 9,8	↑
7: 10,2	←
8: 9,1	←
9: 9,4	←
10: 10,0	↑
Serie:	47,0
Summa:	95,0

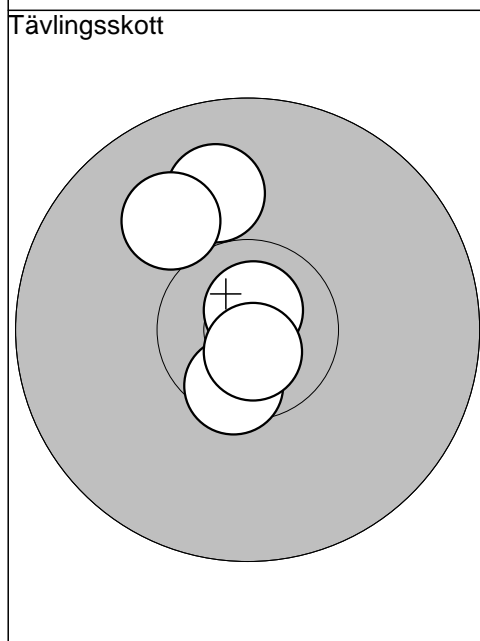

11: 10,0	↑
12: 10,5*	↓
13: 10,8*	↑
14: 10,8*	↓
15: 10,0	↑
Serie:	50,0
Summa:	145,0

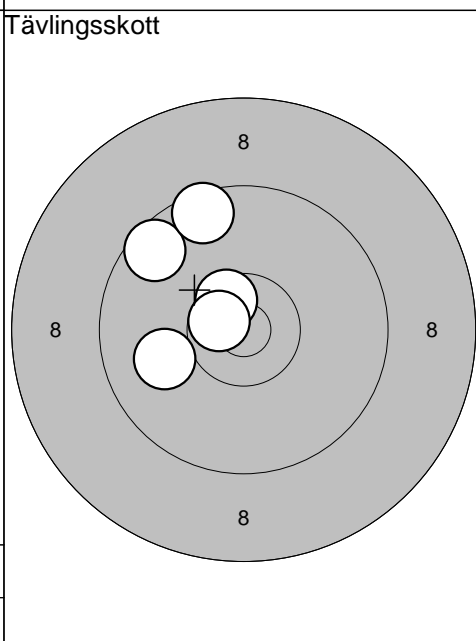

16: 10,6*	↑
17: 10,7*	←
18: 9,6	↑
19: 9,5	↑
20: 10,0	←
Serie:	48,0
Summa:	193,0

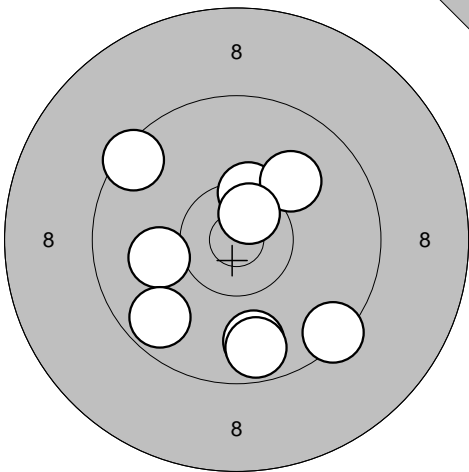
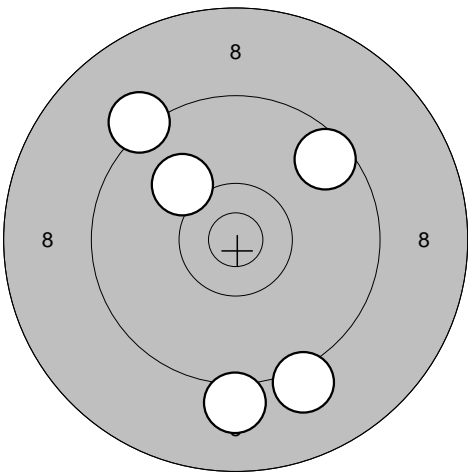
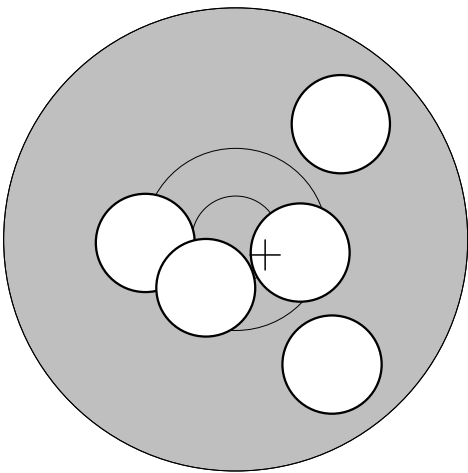
Provsjött 	Final 	Final 
1: 10,4* ↗ 2: 9,8 ↓ 3: 9,4 ↘ 4: 10,0 ↗ 5: 10,0 ← 6: 9,7 ↙ 7: 10,6* ↗ 8: 9,7 ↓ 9: 9,5 ↗	1: 9,2 ↖ 2: 10,1 ↖ 3: 9,6 ↗ 4: 9,1 ↓ 5: 9,1 ↓	11: 9,8 ↓ 12: 9,8 ↗ 13: 10,5* → 14: 10,3* ← 15: 10,5* ↙
Serie: 85,0	Serie: 46,0	Serie: 48,0
Summa: 193,0	Summa: 239,0	Summa: 335,0

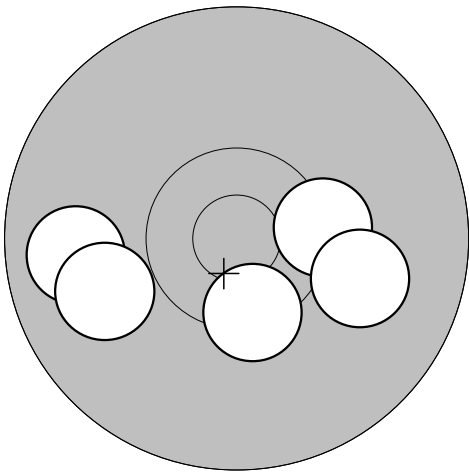
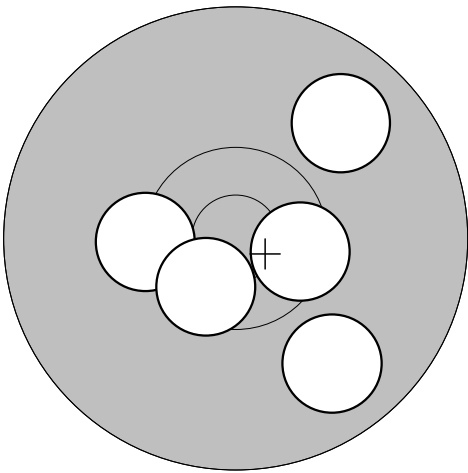
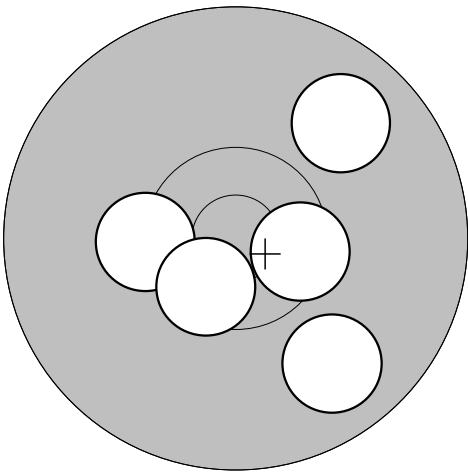
Final 	Final 	Final 
6: 9,8 ← 7: 10,4* ↓ 8: 9,9 ← 9: 10,3* → 10: 10,0 →	11: 9,8 ↓ 12: 9,8 ↗ 13: 10,5* → 14: 10,3* ← 15: 10,5* ↙	11: 9,8 ↓ 12: 9,8 ↗ 13: 10,5* → 14: 10,3* ← 15: 10,5* ↙
Serie: 48,0	Serie: 48,0	Serie: 48,0
Summa: 287,0	Summa: 335,0	Summa: 335,0

Provskott

1: 5,9	→
2: 8,3	↘
3: 6,8	→
4: 7,3	→
5: 8,5	←
6: 10,8*	↑
7: 9,7	↙
8: 10,5*	↘
9: 8,0	←
10: 9,3	←
Serie:	80,0
Summa:	0,0

Provskott

11: 7,7	→
12: 9,3	↙
13: 8,5	↓
14: 9,5	↑
15: 9,9	→
Serie:	42,0
Summa:	0,0

Tävlingsskott

1: 7,7	↓
2: 10,1	↗
3: 8,7	↙
4: 9,6	↘
5: 9,4	←
Serie:	43,0
Summa:	43,0

Tävlingsskott

6: 10,3*	↓
7: 10,2	↘
8: 8,9	↙
9: 8,1	↙
10: 9,8	←
Serie:	45,0
Summa:	88,0

Tävlingsskott

11: 9,5	↓
12: 9,1	↙
13: 9,9	↗
14: 10,5*	↗
15: 9,3	↑
Serie:	46,0
Summa:	134,0

Tävlingsskott

16: 9,9	↗
17: 7,0	→
18: 9,1	↓
19: 10,0	↗
20: 10,0	↙
Serie:	45,0
Summa:	179,0

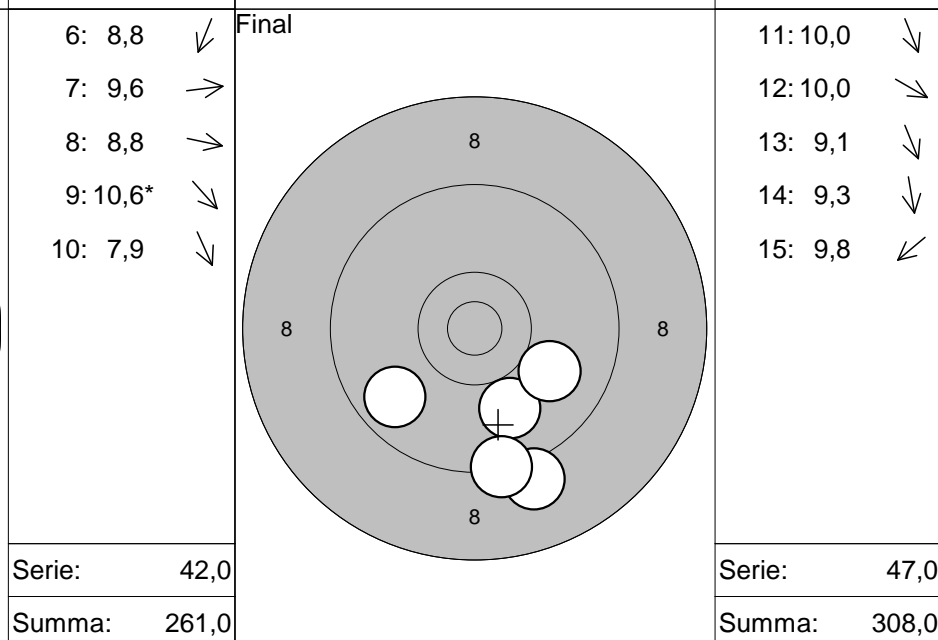
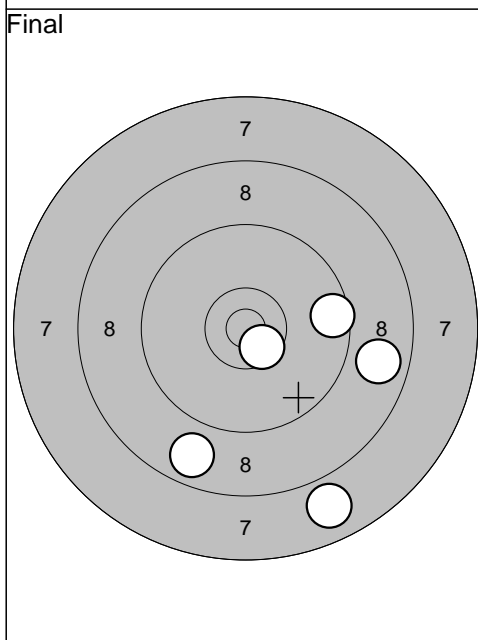
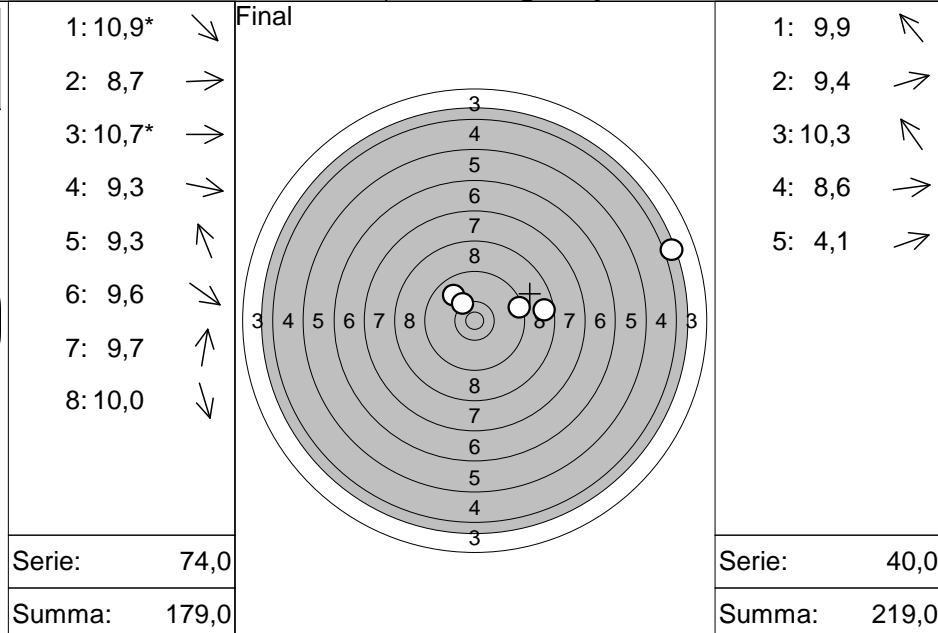
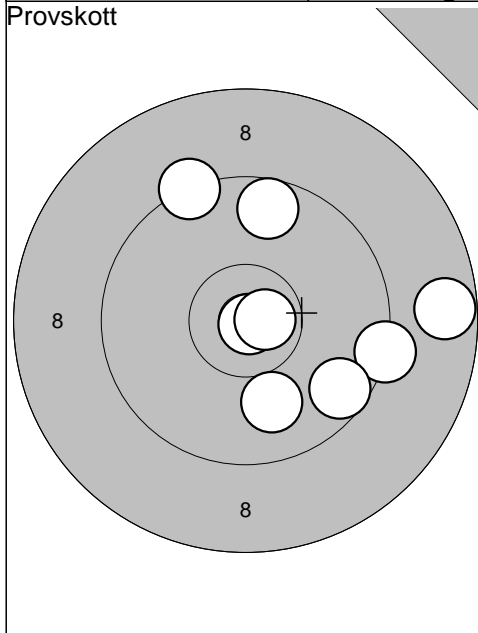

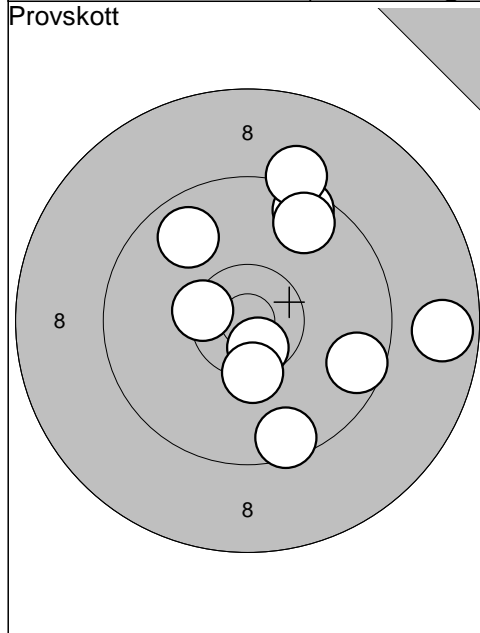

1: 9,8 ↖
2: 9,5 ↗
3: 9,2 ↗
4: 9,7 ↗
5: 9,5 ↘
6: 10,6* ↘
7: 9,6 →
8: 10,3* ↘
9: 8,7 →
10: 10,4* ←
Serie: 92,0
Summa: 0,0

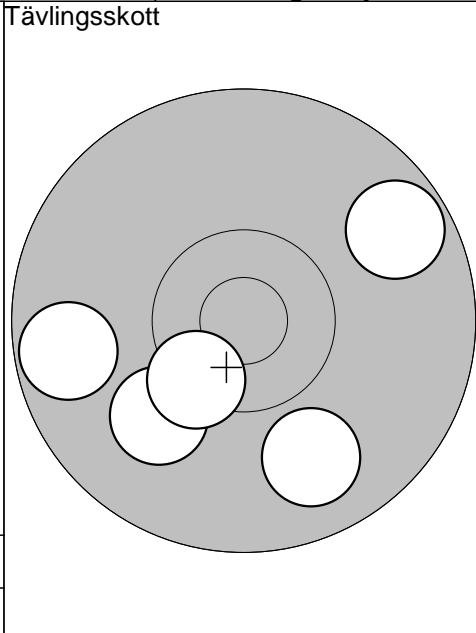

1: 10,0 ↘
2: 9,7 ←
3: 9,9 ↘
4: 10,4* ↘
5: 9,7 ↗
Serie: 47,0
Summa: 47,0

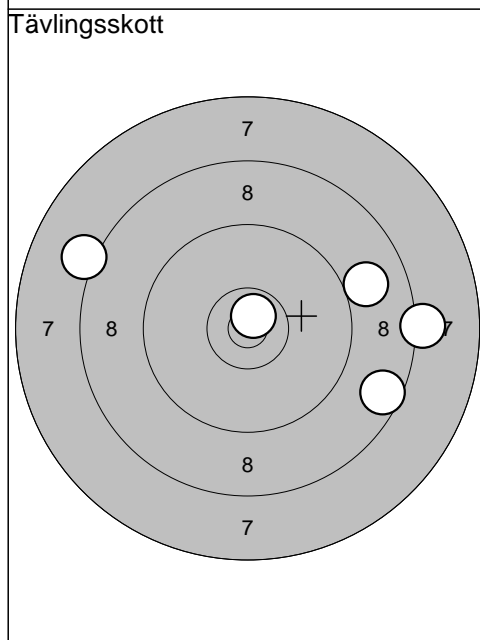

6: 8,1 ←
7: 8,2 →
8: 10,7* ↗
9: 8,6 →
10: 9,0 →
Serie: 43,0
Summa: 90,0

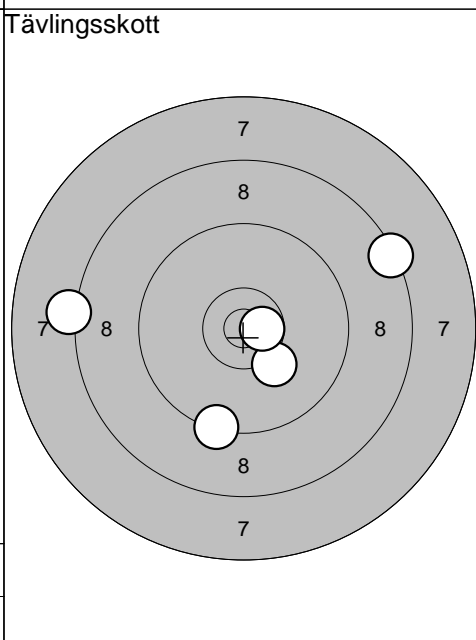

11: 8,4 ↗
12: 9,3 ↘
13: 10,2 ↘
14: 10,6* →
15: 8,2 ←
Serie: 45,0
Summa: 135,0

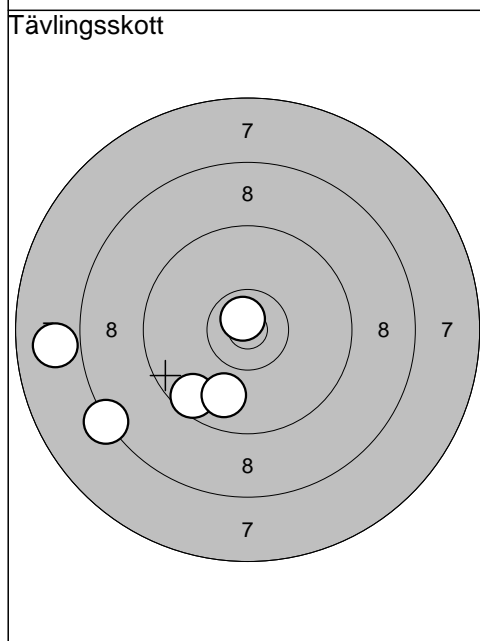

16: 9,6 ↘
17: 10,8* ↗
18: 8,3 ←
19: 9,8 ↘
20: 7,9 ←
Serie: 43,0
Summa: 178,0

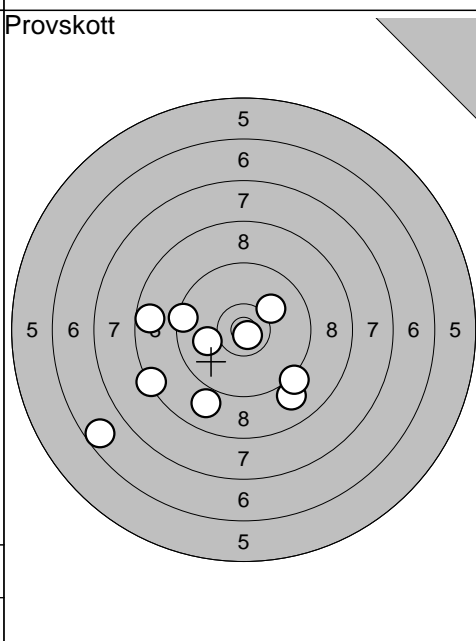

1: 8,9 ↘
2: 6,6 ←
3: 8,4 ←
4: 9,0 ↘
5: 9,2 ↘
6: 10,1 ↗
7: 9,5 ←
8: 10,8* ↘
9: 8,7 ←
10: 10,0 ←
Serie: 87,0
Summa: 178,0

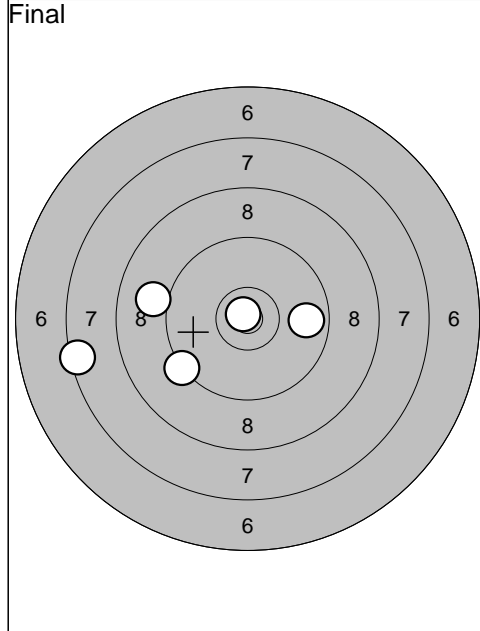

1: 9,8	→
2: 7,5	←
3: 9,0	←
4: 9,3	←
5: 10,8*	↗
Serie: 44,0	
Summa: 222,0	

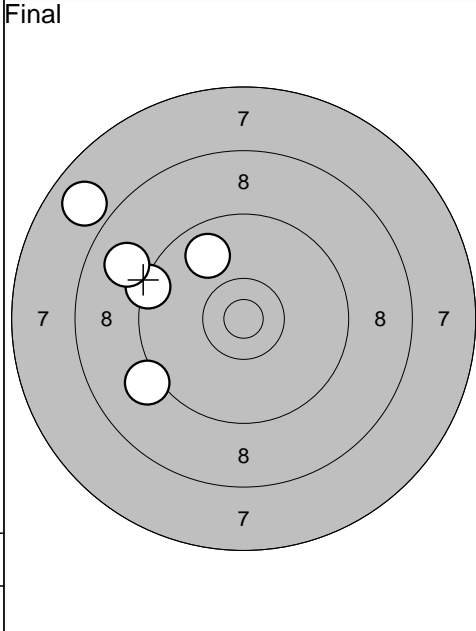

6: 9,4	←
7: 9,8	↑
8: 9,1	←
9: 7,9	←
10: 8,9	←
Serie: 42,0	
Summa: 264,0	

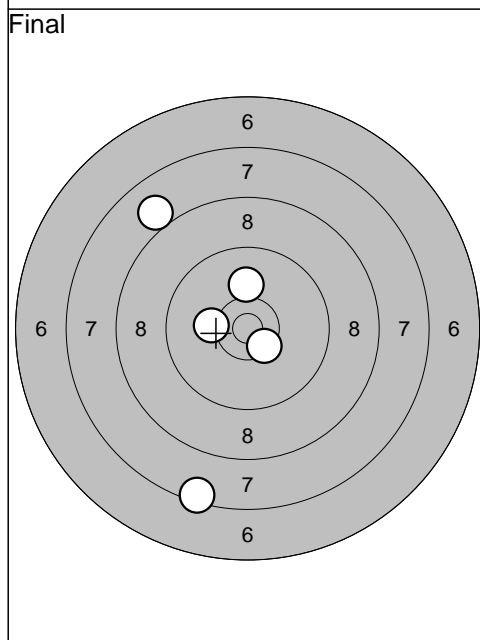

11: 10,2	←
12: 10,1	↑
13: 8,0	↗
14: 7,5	↓
15: 10,5*	↘
Serie: 45,0	
Summa: 309,0	

--	--

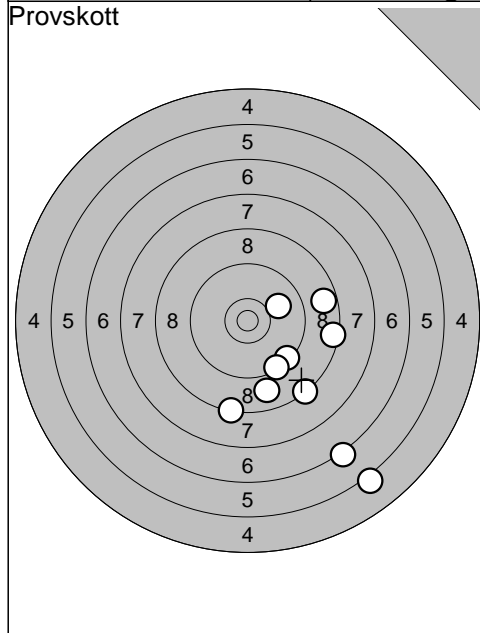

1: 6,2	↘
2: 5,2	↘
3: 8,3	↘
4: 8,5	→
5: 9,4	↘
6: 8,7	→
7: 8,3	↘
8: 9,4	↘
9: 10,0	→
10: 8,9	↘
Serie: 79,0	
Summa: 0,0	

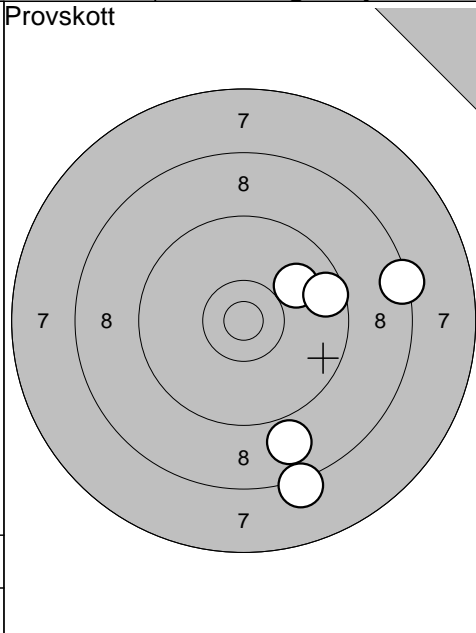

11: 8,9	↘
12: 8,4	→
13: 8,2	↘
14: 10,0	↗
15: 9,6	→
Serie: 43,0	
Summa: 0,0	

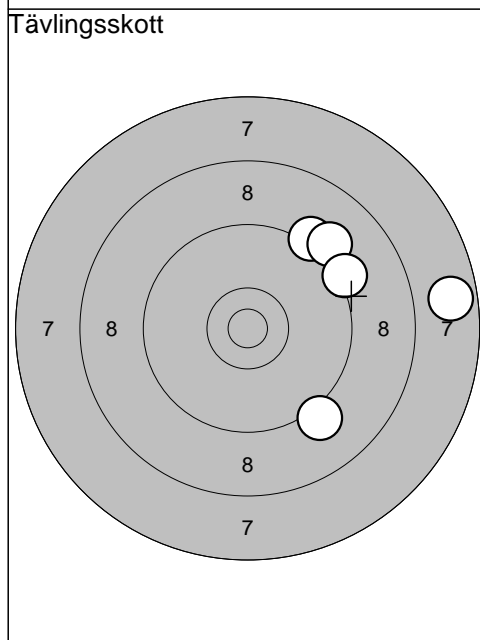

1: 9,2	↗
2: 9,1	↗
3: 9,1	↘
4: 9,2	↗
5: 7,7	→
Serie: 43,0	
Summa: 43,0	

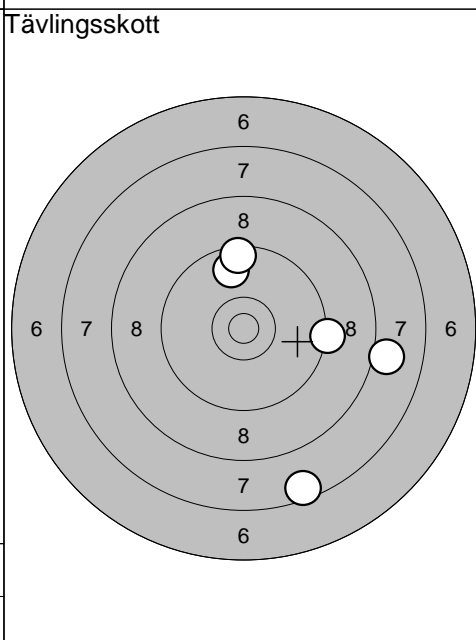

6: 7,5	↘
7: 9,8	↑
8: 9,3	→
9: 9,5	↑
10: 8,0	→
Serie: 42,0	
Summa: 85,0	

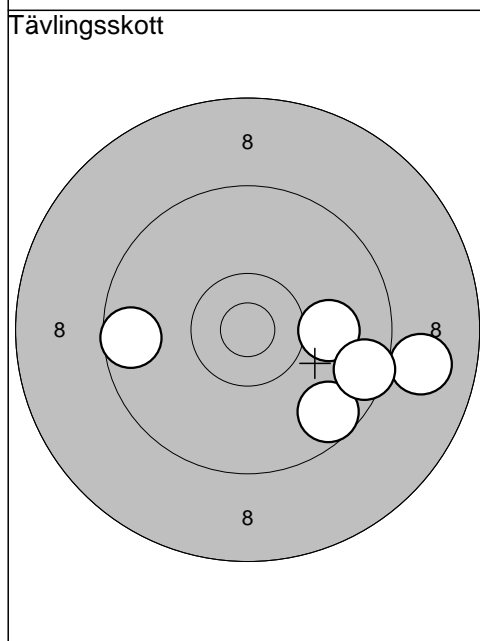

11: 8,9	→
12: 10,0	→
13: 9,6	←
14: 9,6	↘
15: 9,5	↘
Serie: 45,0	
Summa: 130,0	

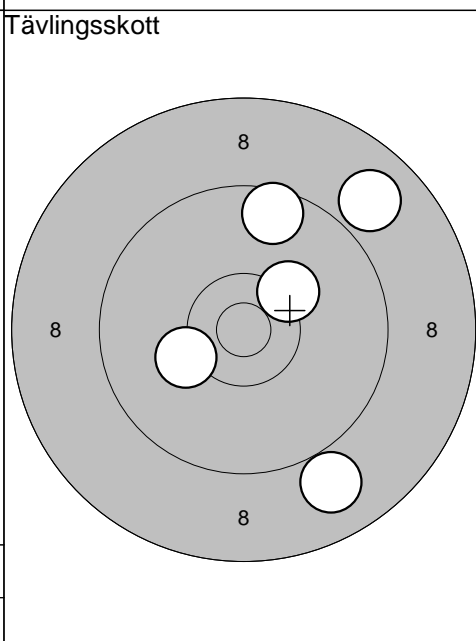

16: 9,6	↑
17: 8,9	↗
18: 8,9	↘
19: 10,2	↙
20: 10,3	↗
Serie: 45,0	
Summa: 175,0	

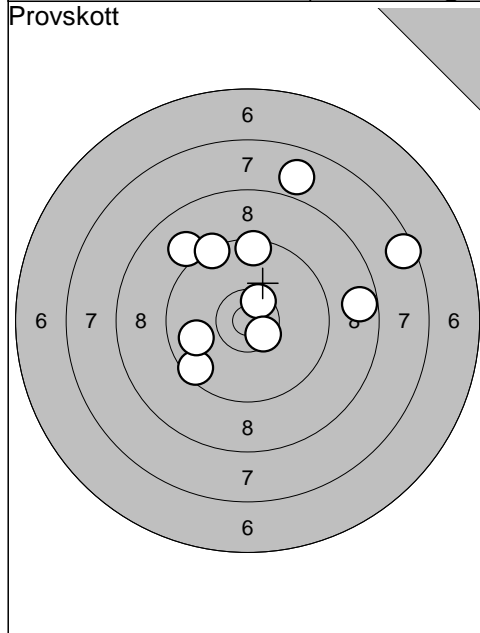

1: 7,9	↗
2: 9,5	↘
3: 8,7	→
4: 7,5	↗
5: 10,5*	↗
6: 9,1	↖
7: 9,4	↖
8: 9,9	↙
9: 10,5*	↘
10: 9,5	↗
Serie:	87,0
Summa:	175,0

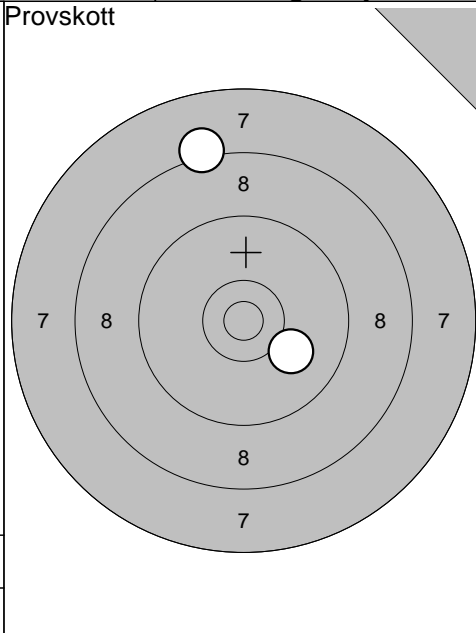

11: 8,2	↗
12: 10,1	↘
Serie:	18,0
Summa:	175,0

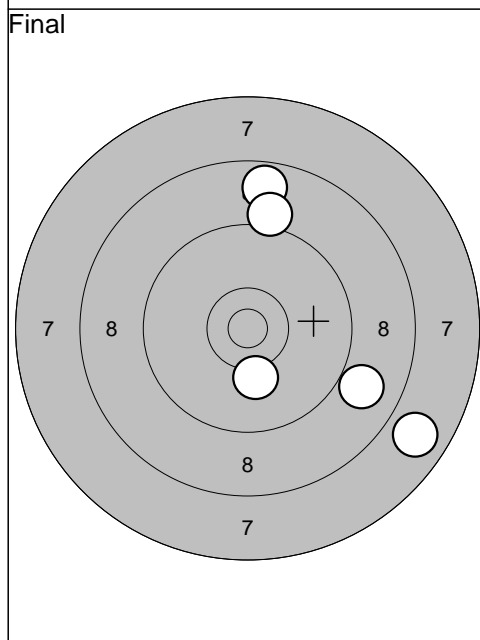

1: 10,2	↘
2: 8,7	↗
3: 9,1	↗
4: 7,8	↘
5: 8,9	↘
Serie:	42,0
Summa:	217,0

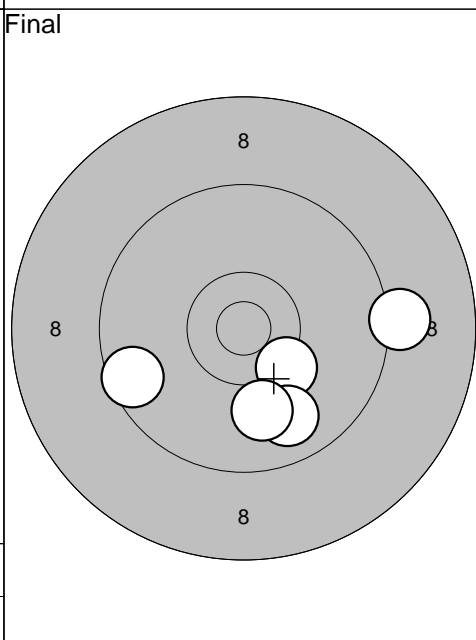

6: 10,3	↘
7: 9,6	↙
8: 9,8	↘
9: 10,0	↘
10: 9,2	→
Serie:	47,0
Summa:	264,0

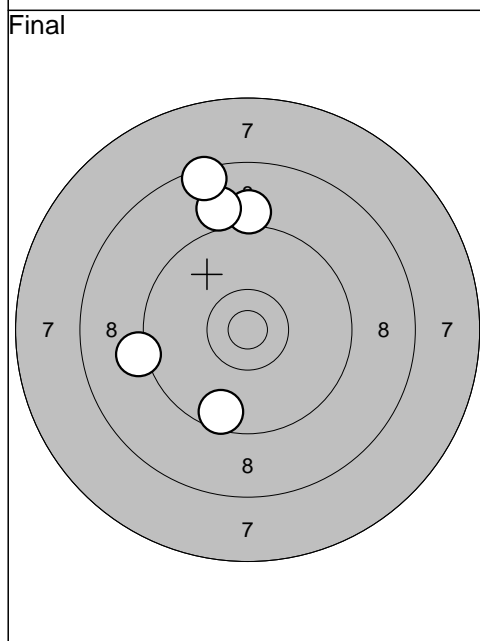

11: 9,1	↗
12: 9,0	↗
13: 8,5	↗
14: 9,6	↘
15: 9,2	↙
Serie:	44,0
Summa:	308,0

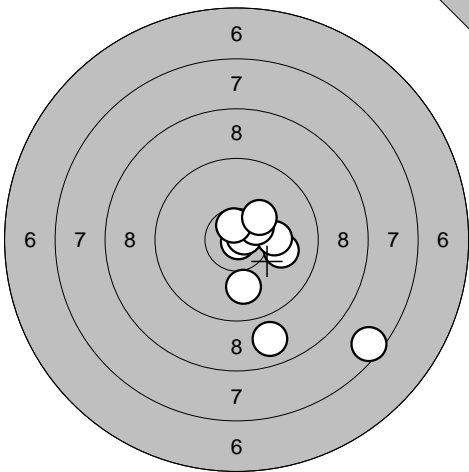
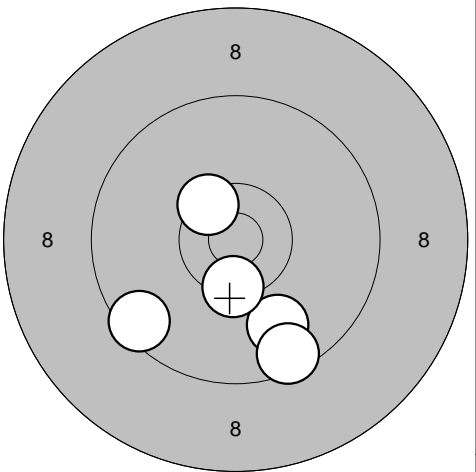
Provskott 	1: 8,8 ↓ 2: 7,6 ↓ 3: 10,9* ↓ 4: 10,0 → 5: 10,8* → 6: 10,0 ↓ 7: 10,2 → 8: 10,5* ↗ 9: 10,7* ↑ 10: 10,3* ↗ <hr/> Serie: 95,0 Summa: 0,0	Tävlingsskott 	1: 9,9 ↓ 2: 9,5 ↙ 3: 10,4* ↗ 4: 10,4* ↓ 5: 9,5 ↓ <hr/> Serie: 47,0 Summa: 47,0
--	---	--	--

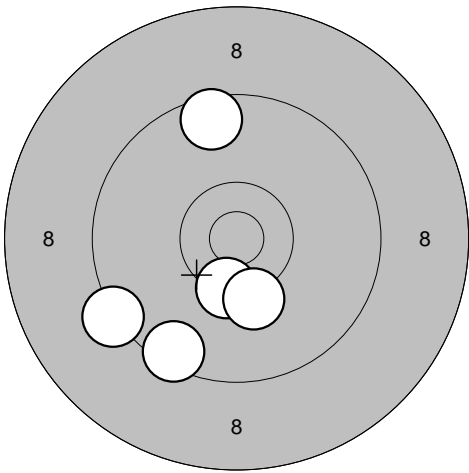
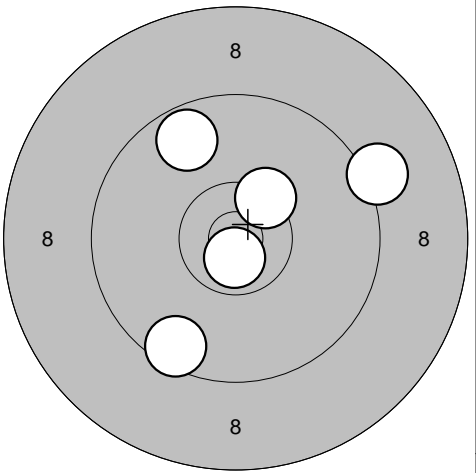
Tävlingsskott 	6: 10,4* ↓ 7: 9,5 ↓ 8: 9,6 ↑ 9: 9,3 ↙ 10: 10,2 ↓ <hr/> Serie: 47,0 Summa: 94,0	Tävlingsskott 	11: 9,5 ↓ 12: 9,2 ↗ 13: 9,7 ↗ 14: 10,7* ↓ 15: 10,4* ↗ <hr/> Serie: 47,0 Summa: 141,0
---	--	---	--

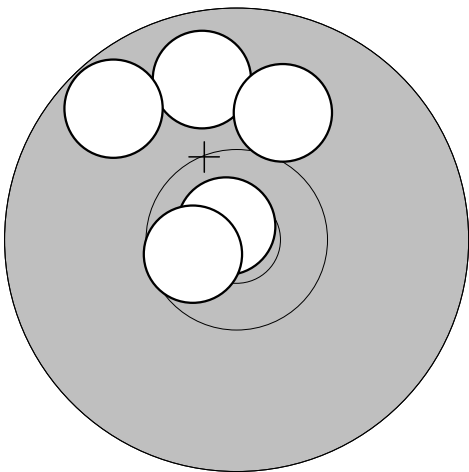
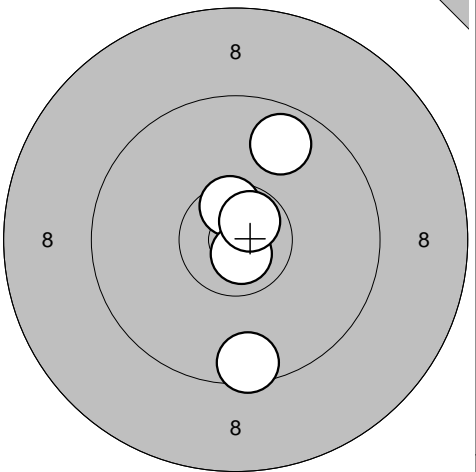
Tävlingsskott 	16: 9,8 ↑ 17: 10,0 ↑ 18: 10,8* ↗ 19: 9,7 ↗ 20: 10,6* ↙ <hr/> Serie: 48,0 Summa: 189,0	Provskott 	1: 10,6* ↑ 2: 9,5 ↓ 3: 9,7 ↗ 4: 10,8* ↓ 5: 10,7* ↗ <hr/> Serie: 48,0 Summa: 189,0
--	---	--	---

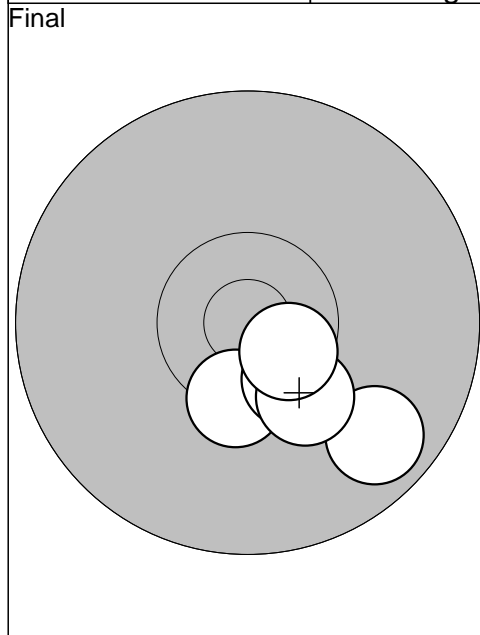

1: 10,4*	↘
2: 10,4*	↘
3: 9,7	↘
4: 10,3	↘
5: 10,6*	↘
Serie: 49,0	
Summa: 238,0	

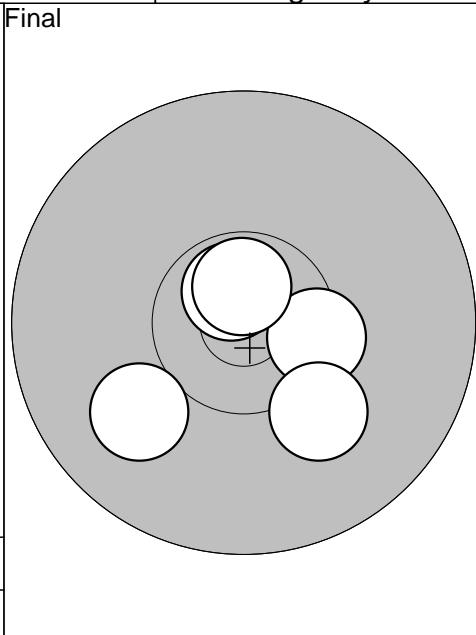

6: 10,0	↙
7: 10,4*	→
8: 10,7*	↗
9: 10,7*	↑
10: 10,1	↘
Serie: 50,0	
Summa: 288,0	

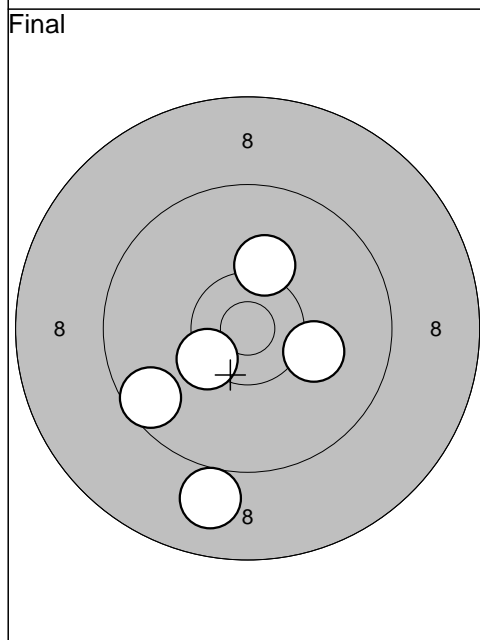

11: 10,1	→
12: 10,4*	↙
13: 9,0	↘
14: 10,2	↗
15: 9,6	↙
Serie: 48,0	
Summa: 336,0	

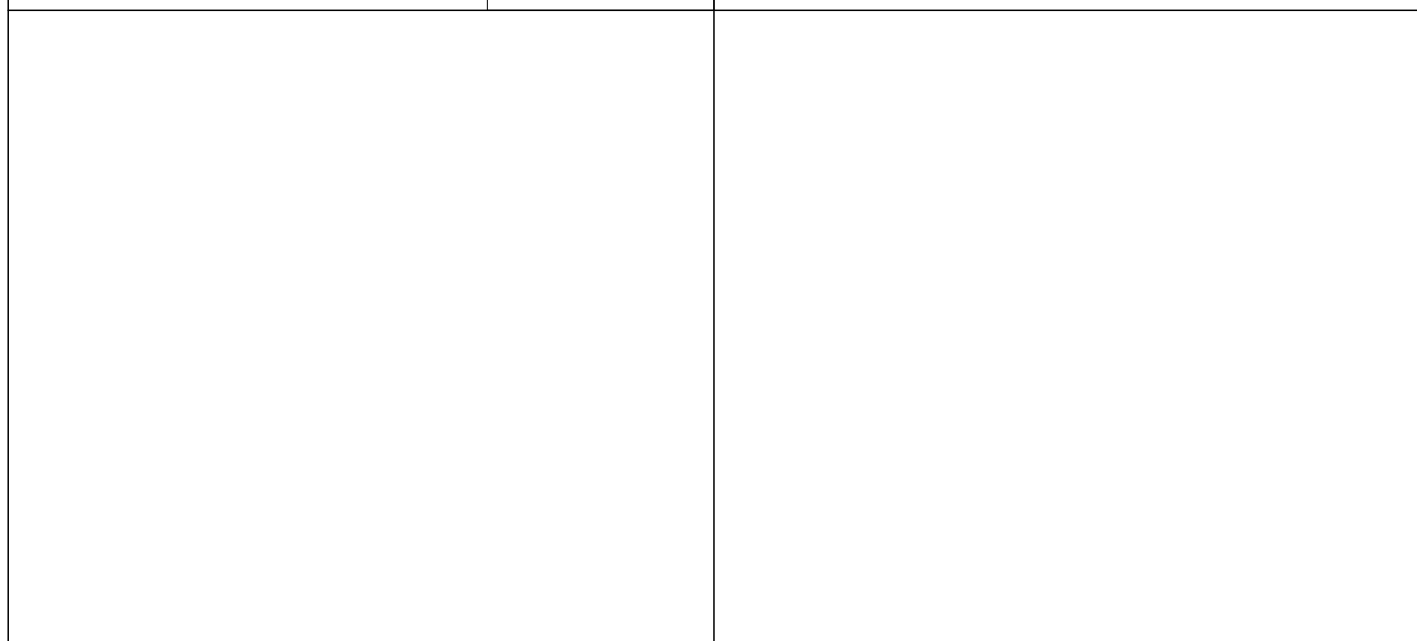

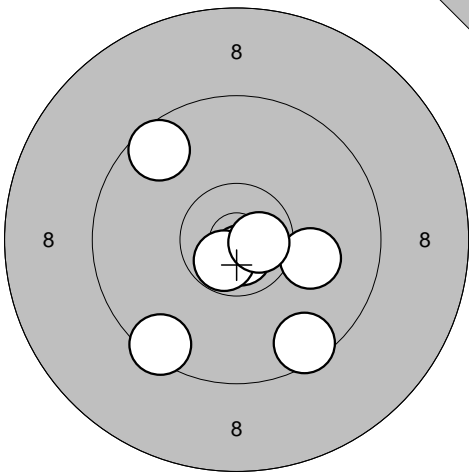
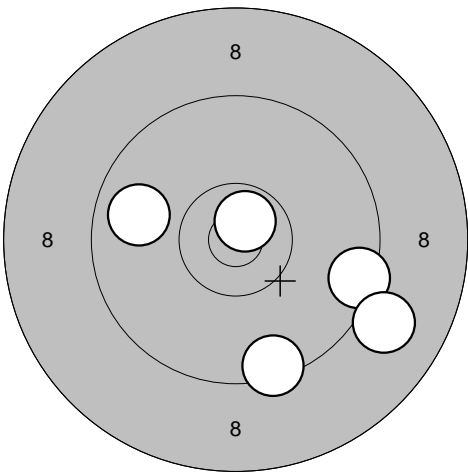
<p>Provskott</p> 	<p>1: 9,6 ↗ 2: 9,5 ↘ 3: 9,5 ↘ 4: 10,8* ↘ 5: 10,1 → 6: 10,7* ↘ 7: 10,7* →</p> <p>Serie: 67,0 Summa: 0,0</p>	<p>Tävlingskott</p> 	<p>1: 9,4 ↘ 2: 9,5 → 3: 9,0 ↘ 4: 9,8 ← 5: 10,7* ↗</p> <p>Serie: 46,0 Summa: 46,0</p>
---	--	--	--

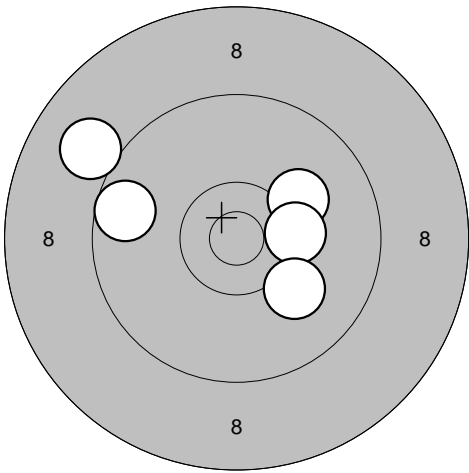
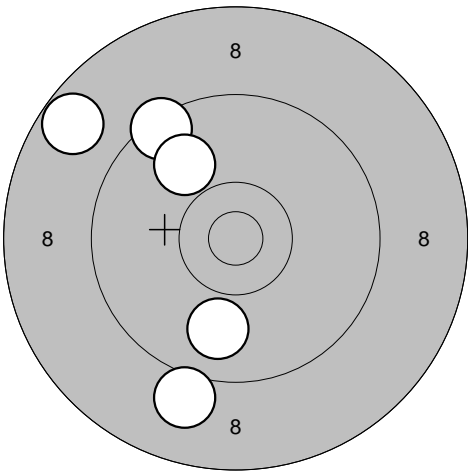
<p>Tävlingskott</p> 	<p>6: 10,1 ↗ 7: 10,3 → 8: 9,0 ↗ 9: 10,1 ↘ 10: 9,6 ←</p> <p>Serie: 48,0 Summa: 94,0</p>	<p>Tävlingskott</p> 	<p>11: 9,4 ↗ 12: 9,0 ↘ 13: 9,9 ↗ 14: 9,9 ↘ 15: 8,7 ↗</p> <p>Serie: 44,0 Summa: 138,0</p>
---	--	---	--

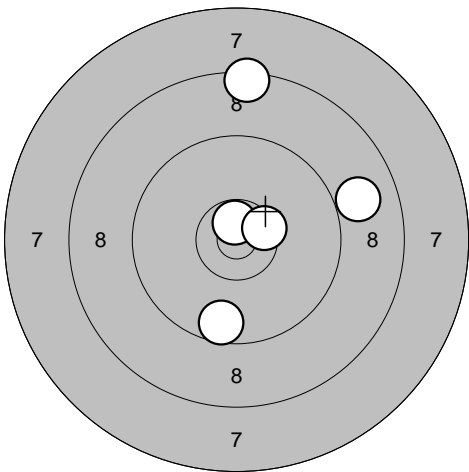
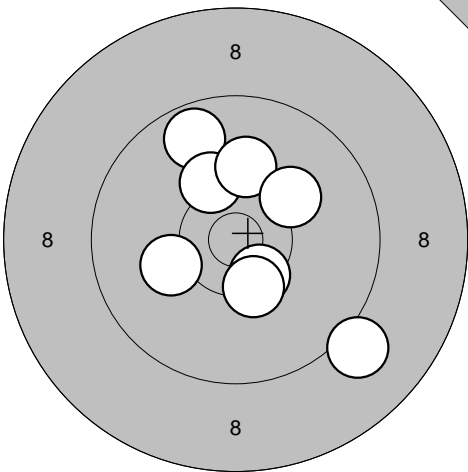
<p>Tävlingskott</p> 	<p>16: 10,7* ↑ 17: 9,6 ↘ 18: 8,4 ↑ 19: 10,5* → 20: 8,9 →</p> <p>Serie: 45,0 Summa: 183,0</p>	<p>Provskott</p> 	<p>1: 10,5* ↘ 2: 9,1 ↘ 3: 9,7 ↗ 4: 10,2 ↗ 5: 10,4* ↘ 6: 10,1 ↑ 7: 10,2 ↗ 8: 10,2 ←</p> <p>Serie: 78,0 Summa: 183,0</p>
--	--	---	--

